

Competenza, Ricerca e Sviluppo.

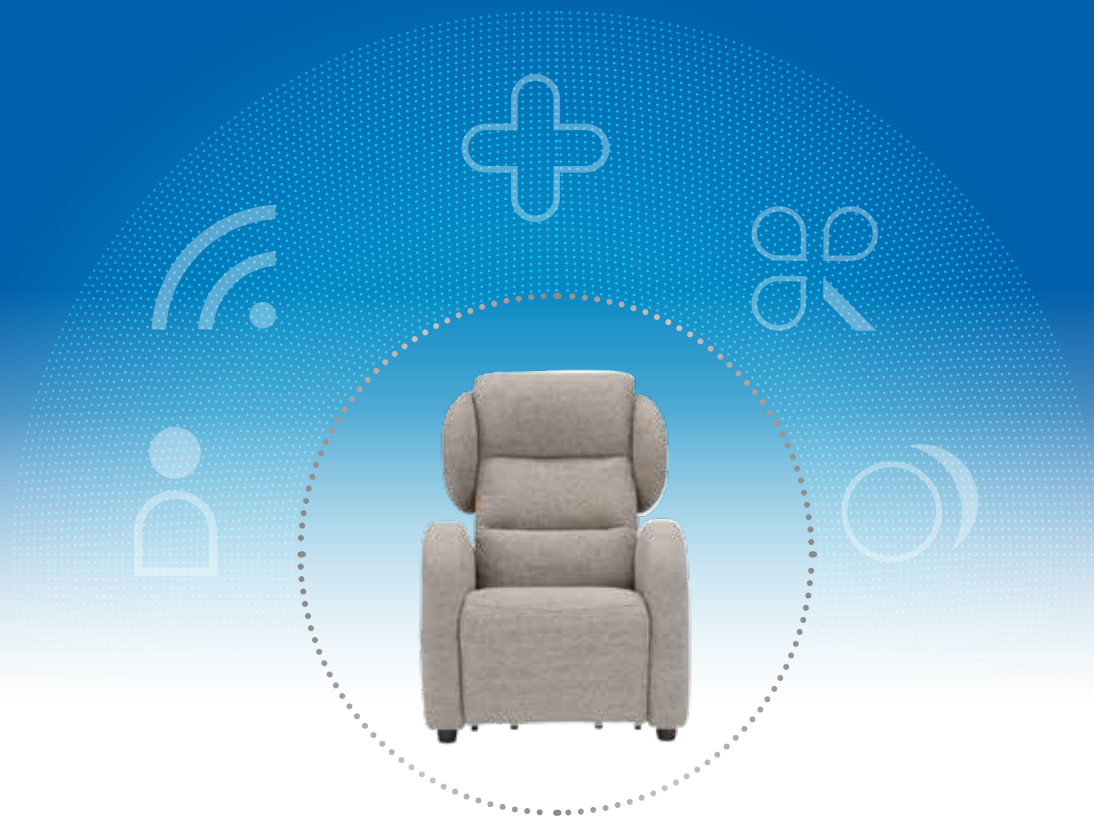

Poltrone **Intermed**



System of certified
management Organization
UNI EN ISO 9001:2008
UNI CEI EN ISO 13485:2012



Le poltrone sono realizzate a mano,
una a una, con cura, in Italia, da giovani
tecnici appassionati.

100%

MADE IN ITALY

INDICE

Chanel.....	4
Vanity	8
Minù.....	12
Metrò	16
Mirò.....	20
Mamy.....	24
Bourbon	28
Nuvola	32
Galà	36
Easy.....	40
Heven	44
Bonton.....	48
Tavole tecniche	54

Chanel

Poltrona classica confortevole in perfetto stile Berger, funzionale ed elegante, protagonista dell'arredo.









Relax Totale

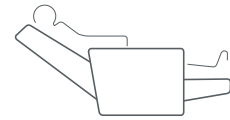

Posizione di totale estensione della poltrona per raggiungere la funzione letto.



Posizione TV

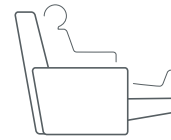

Posizione che grazie all'apertura della sola pediera permette una comoda visione della tv.



Alzapersona



Grazie alla funzione LIFT, è possibile il sollevamento della seduta. Questa posizione aiuta l'utilizzatore in caso di difficoltà motoria.

Vanity

Restyling della classica poltrona Berger, Vanity si distingue per l'equilibrio delle forme e l'eleganza delle proporzioni.









Relax Totale

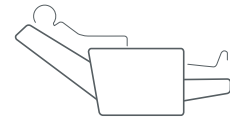

Posizione di totale estensione della poltrona per raggiungere la funzione letto.



Posizione TV

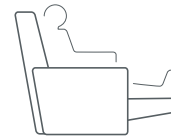

Posizione che grazie all'apertura della sola pediera permette una comoda visione della tv.



Alzapersona



Grazie alla funzione LIFT, è possibile il sollevamento della seduta. Questa posizione aiuta l'utilizzatore in caso di difficoltà motoria.

Minù

Le linee morbide disegnano questa poltrona contenuta negli ingombri. Caratterizzata dall'alta spalliera con orecchie laterali e dagli accoglienti braccioli, Minù è una poltrona che coniuga funzionalità e stile.









Relax Totale

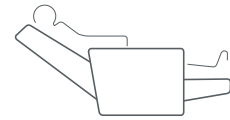

Posizione di totale estensione della poltrona per raggiungere la funzione letto.



Posizione TV

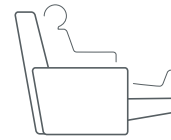

Posizione che grazie all'apertura della sola pediera permette una comoda visione della tv.



Alzapersona



Grazie alla funzione LIFT, è possibile il sollevamento della seduta. Questa posizione aiuta l'utilizzatore in caso di difficoltà motoria.

Metrò

Lineare ed elegante, Metrò è una poltrona contenuta negli ingombri. Il comfort dell'alta spalliera è enfatizzato dal volume del poggiatesta, in perfetta armonia di forma con la morbidezza dei braccioli.









Relax Totale

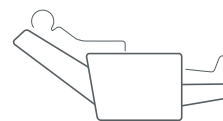

Posizione di totale estensione della poltrona per raggiungere la funzione letto.



Posizione TV



Posizione che grazie all'apertura della sola pediera permette una comoda visione della tv.



Alzapersona



Grazie alla funzione LIFT, è possibile il sollevamento della seduta. Questa posizione aiuta l'utilizzatore in caso di difficoltà motoria.

Miró

Elegante, contenuta nelle forme e costruita in modo modulare per assicurare maggiore versatilità. Miró risponde con stile e carattere alle necessità di una poltrona sanitaria.









Relax Totale

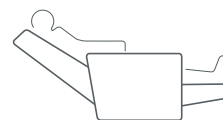

Posizione di totale estensione della poltrona per raggiungere la funzione letto.



Posizione TV



Posizione che grazie all'apertura della sola pediera permette una comoda visione della tv.



Alzapersona



Grazie alla funzione LIFT, è possibile il sollevamento della seduta. Questa posizione aiuta l'utilizzatore in caso di difficoltà motoria.

Mamy

Linee morbide ed accoglienti, particolari curati ed eccellente comfort. Mamy rivisita lo stile classico della poltrona relax con carattere ed estro.









Relax Totale

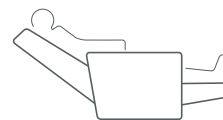

Posizione di totale estensione della poltrona per raggiungere la funzione letto.



Posizione TV



Posizione che grazie all'apertura della sola pediera permette una comoda visione della tv.



Alzapersona



Grazie alla funzione LIFT, è possibile il sollevamento della seduta. Questa posizione aiuta l'utilizzatore in caso di difficoltà motoria.

Bourbon

Semplice ma elegante, Bourbon garantisce un elevato comfort, sottolineato dall'alta spalliera e dal morbido poggiatesta.



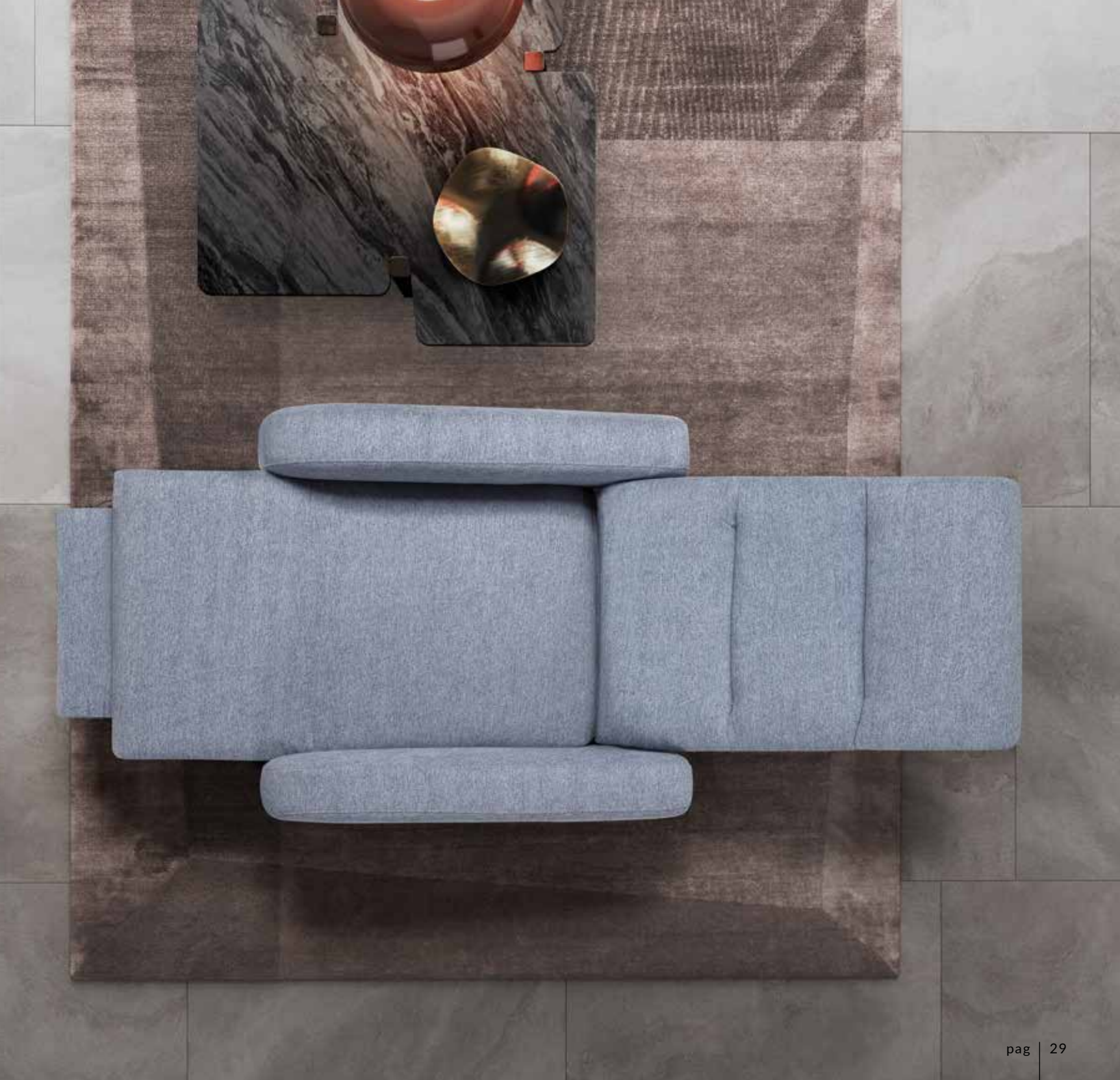





Relax Totale

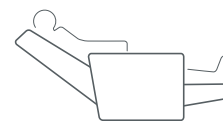

Posizione di totale estensione della poltrona per raggiungere la funzione letto.



Posizione TV



Posizione che grazie all'apertura della sola pediera permette una comoda visione della tv.



Alzapersona



Grazie alla funzione LIFT, è possibile il sollevamento della seduta. Questa posizione aiuta l'utilizzatore in caso di difficoltà motoria.

Nuvola

Grandi superfici morbide e confortevoli, linee classiche, ampia spalliera e braccioli accoglienti, tutti elementi che fanno di questa poltrona il top delle soluzioni relax.









Relax Totale

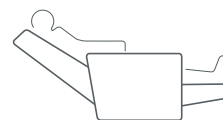

Posizione di totale estensione della poltrona per raggiungere la funzione letto.



Posizione TV



Posizione che grazie all'apertura della sola pediera permette una comoda visione della tv.



Alzapersona



Grazie alla funzione LIFT, è possibile il sollevamento della seduta. Questa posizione aiuta l'utilizzatore in caso di difficoltà motoria.

Galá

Poltrona confortevole e funzionale che fonde lo stile scandinavo con il gusto mediterraneo. L'alta e sagomata spalliera si sviluppa su un disegno ergonomico e assicura un relax intenso.







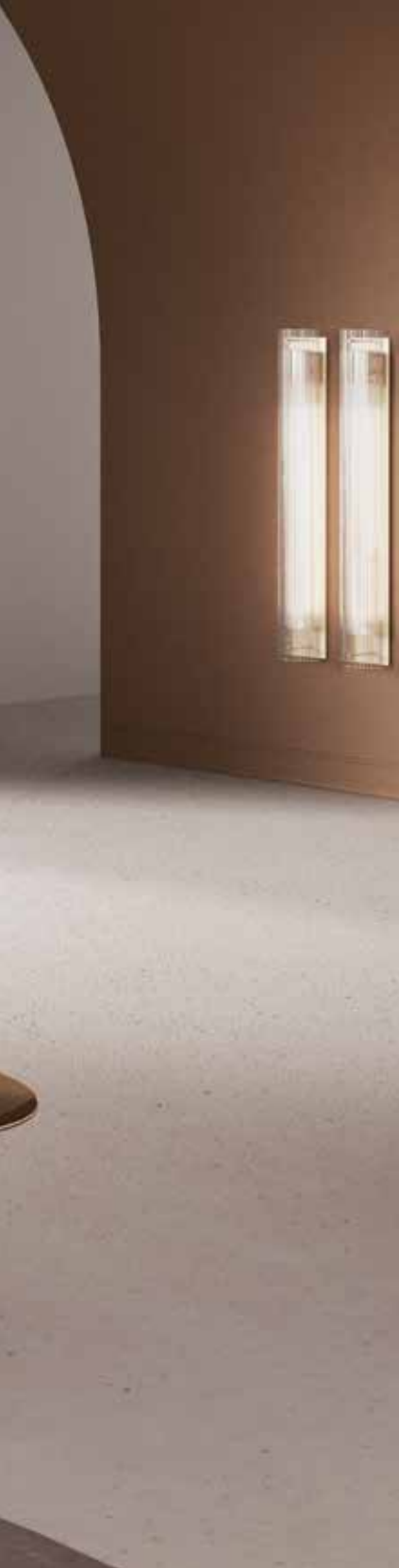

Relax Totale



Posizione di totale estensione della poltrona per raggiungere la funzione letto.



Posizione TV



Posizione che grazie all'apertura della sola pediera permette una comoda visione della tv.



Alzapersona



Grazie alla funzione LIFT, è possibile il sollevamento della seduta. Questa posizione aiuta l'utilizzatore in caso di difficoltà motoria.

Easy

Modello realizzato con misure contenute e con spalliera ampia ed avvolgente. Easy è caratterizzata da uno stile casual e versatile che si adatta con personalità ad ogni ambiente.



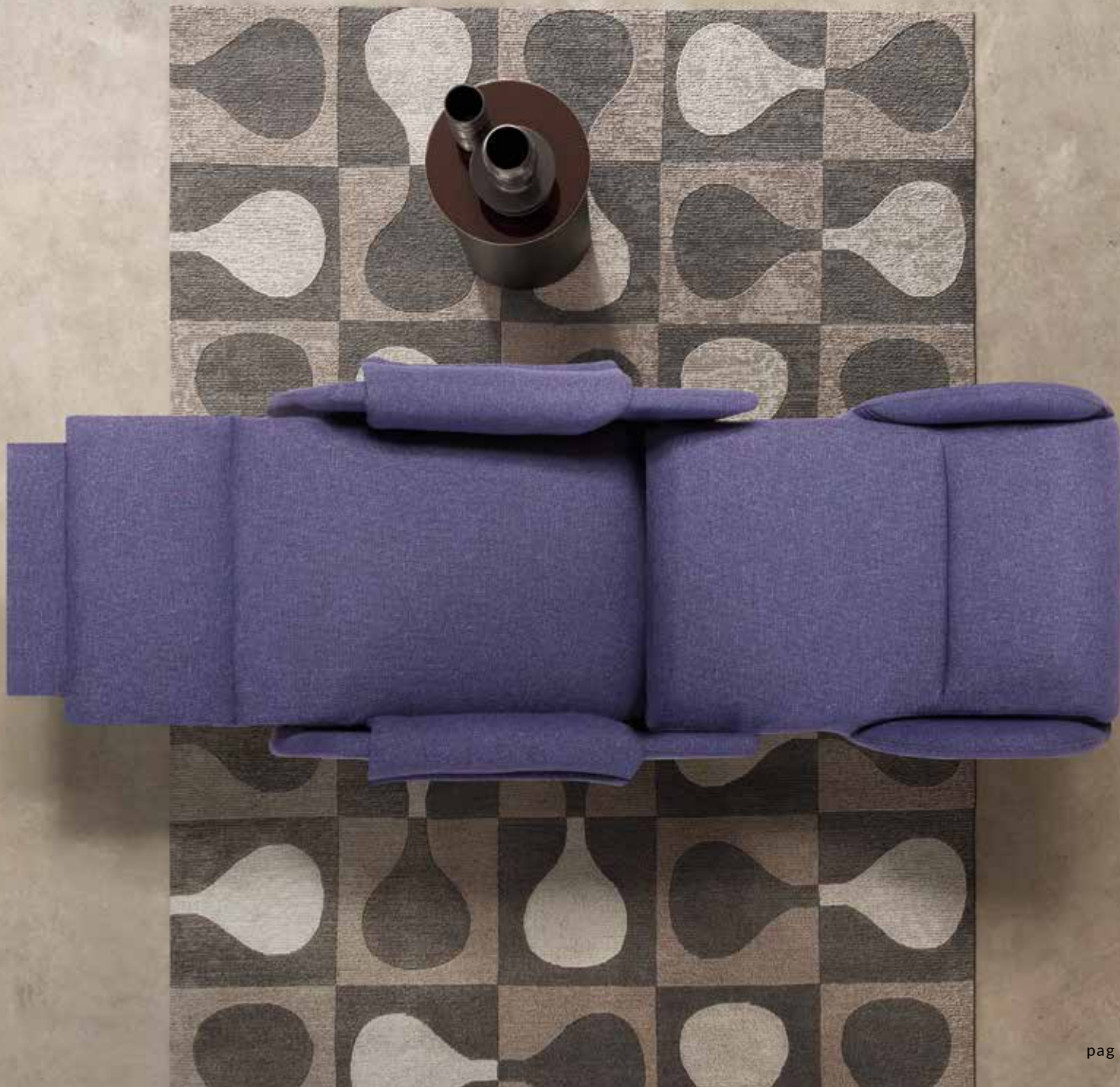





Relax Totale

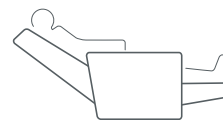

Posizione di totale estensione della poltrona per raggiungere la funzione letto.



Posizione TV



Posizione che grazie all'apertura della sola pediera permette una comoda visione della tv.



Alzapersona



Grazie alla funzione LIFT, è possibile il sollevamento della seduta. Questa posizione aiuta l'utilizzatore in caso di difficoltà motoria.

Heven

Sagomato secondo canoni collaudati di comfort ed ergonomia, il modello Heven si presenta come un modello solido e funzionale, che risponde a tutte le esigenze di relax.









Relax Totale

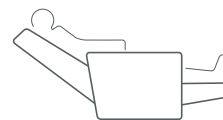

Posizione di totale estensione della poltrona per raggiungere la funzione letto.



Posizione TV



Posizione che grazie all'apertura della sola pediera permette una comoda visione della tv.



Alzapersona



Grazie alla funzione LIFT, è possibile il sollevamento della seduta. Questa posizione aiuta l'utilizzatore in caso di difficoltà motoria.

Bonton

Confortevole e funzionale, costruita in modo modulare per assicurare maggiore versatilità, Bonton risponde con stile e carattere alle necessità di una poltrona sanitaria.









Relax Totale

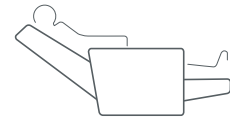

Posizione di totale estensione della poltrona per raggiungere la funzione letto.



Posizione TV

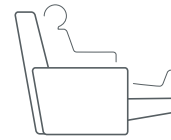

Posizione che grazie all'apertura della sola pediera permette una comoda visione della tv.



Alzapersona



Grazie alla funzione LIFT, è possibile il sollevamento della seduta. Questa posizione aiuta l'utilizzatore in caso di difficoltà motoria.



Bonton è prodotta di serie con braccioli e orecchie estraibili. Funzione che permette alla poltrona di essere utilizzata come normale seduta di un tavolo da pranzo. La poltrona può essere accessoriata con tavolino mobile.



Posizione di seduta standard con orecchie e braccioli



Posizione con tavolino optional (senza orecchie e braccioli)



Posizione sotto tavolo (senza orecchie e braccioli)





TAVOLE TECNICHE



Chanel

dispositivo medico

Poltrona Lift-Relax realizzata con meccanismo motorizzato. La struttura solida è assemblata con parti esterne e interne in agglomerato di legno (multistrato e massello di legno) ricoperta da poliuretano espanso indeformabile. Rivestimento in Tessuto/ Ecopelle/Pelle. Non sfoderabile. Piedi in PVC.

CND: Y123606

Repertorio: 2176653

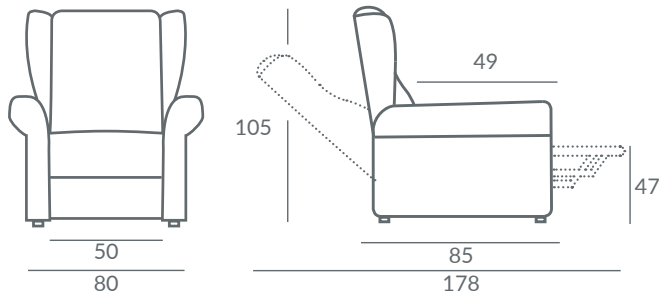

Vanity

dispositivo medico

Poltrona Lift-Relax realizzata con meccanismo motorizzato. La struttura solida è assemblata con parti esterne e interne in agglomerato di legno (multistrato e massello di legno) ricoperta da poliuretano espanso indeformabile. Rivestimento in Tessuto/ Ecopelle/Pelle. Non sfoderabile. Piedi in PVC.

CND: Y123606

Repertorio: 2176662

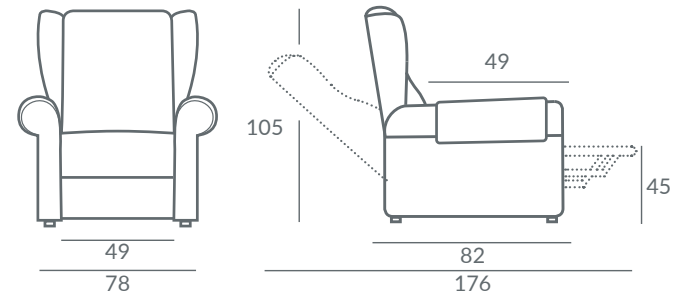

VERSIONE



Meccanica Lift-Relax 1 Motore



Meccanica Lift-Relax 2 Motori

OPTIONAL

Roller System



Kit 5 Vibro



Kit Batteria
60 Cicli



Doppia Tavoletta

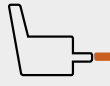

Zero Gravity



Copripoltrone



Maniglione



BF 15



Braccioli estraibili



Tavolino



VERSIONE



Meccanica Lift-Relax 1 Motore



Meccanica Lift-Relax 2 Motori

OPTIONAL

Roller System



Kit 5 Vibro



Kit Batteria
60 Cicli



Doppia Tavoletta



Zero Gravity



Copripoltrone



Maniglione



BF 15



Braccioli estraibili



Tavolino





Minù

dispositivo medico

Poltrona Lift-Relax realizzata con meccanismo motorizzato. La struttura solida è assemblata con parti esterne e interne in agglomerato di legno (multistrato e massello di legno) ricoperta da poliuretano espanso indeformabile. Rivestimento in Tessuto/ Ecopelle/Pelle. Non sfoderabile. Piedi in Legno.

CND: Y123606

Repertorio: 2176659

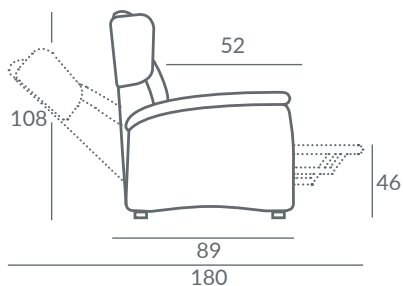
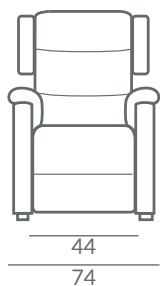

VERSIONE



Meccanica Lift-Relax 1 Motore



Meccanica Lift-Relax 2 Motori

OPTIONAL

Roller System



Kit Batteria
60 Cicli



Doppia Tavoletta



Zero Gravity



Copripoltrone



Maniglione



Orecchie
Estraibili di serie



Metrò

dispositivo medico

Poltrona Lift-Relax realizzata con meccanismo motorizzato. La struttura solida è assemblata con parti esterne e interne in agglomerato di legno (multistrato e massello di legno) ricoperta da poliuretano espanso indeformabile. Rivestimento in Tessuto/ Ecopelle/Pelle. Non sfoderabile. Piedi in Legno.

CND: Y123606

Repertorio: 2176658

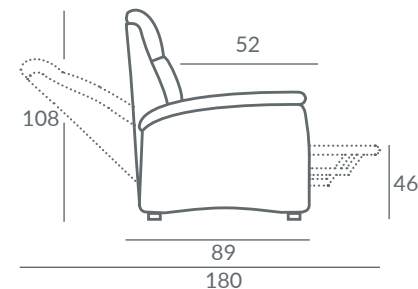
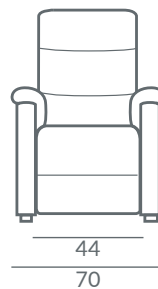

VERSIONE



Meccanica Lift-Relax 1 Motore



Meccanica Lift-Relax 2 Motori

OPTIONAL

Roller System



Kit Batteria
60 Cicli



Doppia Tavoletta



Zero Gravity

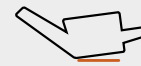

Copripoltrone



Maniglione





MIRÓ

dispositivo medico

Poltrona Lift-Relax realizzata con meccanismo motorizzato. La struttura solida è assemblata con parti esterne e interne in agglomerato di legno (multistrato e massello di legno) ricoperta da poliuretano espanso indeformabile. Rivestimento in Tessuto/ Ecopelle/Pelle. Non sfoderabile. Piedi in PVC.

CND: Y123606

Repertorio: 2176660

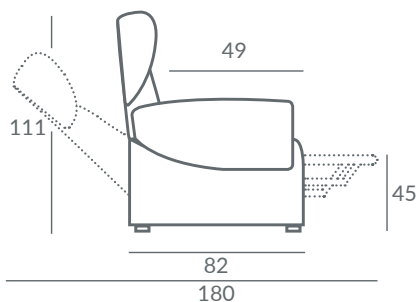
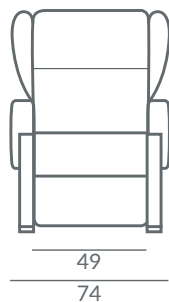

MAMY

dispositivo medico

Poltrona Lift-Relax realizzata con meccanismo motorizzato. La struttura solida è assemblata con parti esterne e interne in agglomerato di legno (multistrato e massello di legno) ricoperta da poliuretano espanso indeformabile. Rivestimento in Tessuto/ Ecopelle/Pelle. Non sfoderabile. Piedi in PVC.

CND: Y123606

Repertorio: 2176657

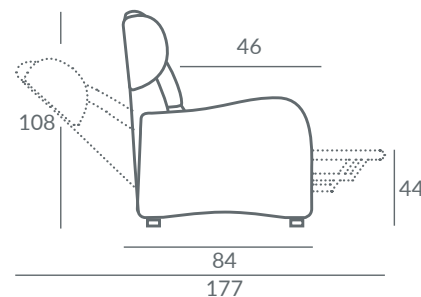

VERSIONE



Meccanica Lift-Relax 1 Motore



Meccanica Lift-Relax 2 Motori

OPTIONAL

Roller System



Kit Batteria
60 Cicli



Doppia Tavoletta

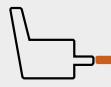

Zero Gravity



Copripoltrone



Maniglione



Braccioli
Estraibili di serie



Tavolino



VERSIONE



Meccanica Lift-Relax 1 Motore



Meccanica Lift-Relax 2 Motori

OPTIONAL

Roller System



Kit Batteria
60 Cicli



Doppia Tavoletta



Zero Gravity

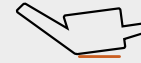

Copripoltrone



Maniglione



Orecchie
Estraibili di serie





BOURBON

dispositivo medico

Poltrona Lift-Relax realizzata con meccanismo motorizzato. La struttura solida è assemblata con parti esterne e interne in agglomerato di legno (multistrato e massello di legno) ricoperta da poliuretano espanso indeformabile. Rivestimento in Tessuto/ Ecopelle/Pelle. Non sfoderabile. Piedi in PVC.

CND: Y123606

Repertorio: 2176652

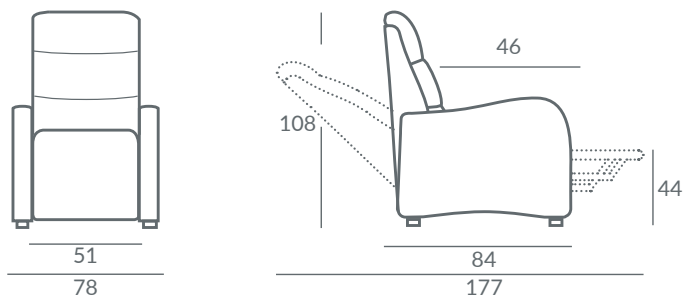

NUVOLA

dispositivo medico

Poltrona Lift-Relax realizzata con meccanismo motorizzato. La struttura solida è assemblata con parti esterne e interne in agglomerato di legno (multistrato e massello di legno) ricoperta da poliuretano espanso indeformabile. Rivestimento in Tessuto/ Ecopelle/Pelle. Non sfoderabile. Piedi in PVC.

CND: Y123606

Repertorio: 2176661

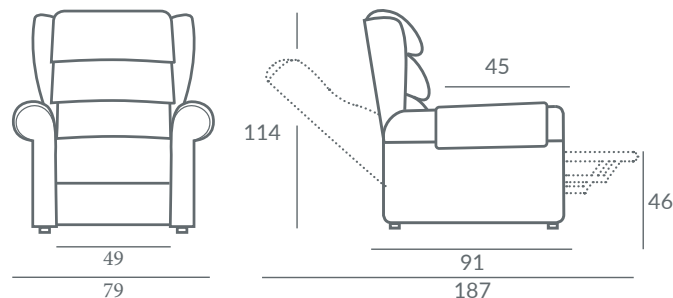

VERSIONE



Meccanica Lift-Relax 1 Motore



Meccanica Lift-Relax 2 Motori

OPTIONAL

Roller System



Kit Batteria
60 Cicli



Doppia Tavoletta



Zero Gravity



Copripoltrone



Maniglione



VERSIONE



Meccanica Lift-Relax 1 Motore



Meccanica Lift-Relax 2 Motori

OPTIONAL

Roller System



Kit Batteria
60 Cicli



Doppia Tavoletta



Zero Gravity



Copripoltrone



Maniglione



Braccioli
Estraibili



Tavolino





GALÁ

dispositivo medico

Poltrona Lift-Relax realizzata con meccanismo motorizzato. La struttura solida è assemblata con parti esterne e interne in agglomerato di legno (multistrato e massello di legno) ricoperta da poliuretano espanso indeformabile. Rivestimento in Tessuto/ Ecopelle/Pelle. Non sfoderabile. Piedi in PVC.

CND: Y123606

Repertorio: 2176655

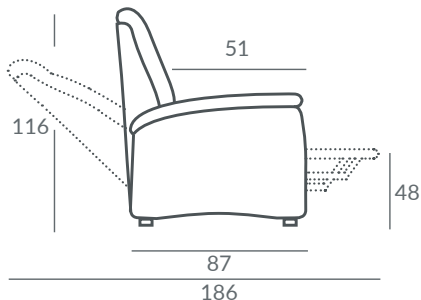
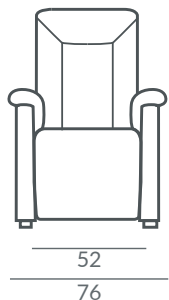

EASY

dispositivo medico

Poltrona Lift-Relax realizzata con meccanismo motorizzato. La struttura solida è assemblata con parti esterne e interne in agglomerato di legno (multistrato e massello di legno) ricoperta da poliuretano espanso indeformabile. Rivestimento in Tessuto/ Ecopelle/Pelle. Non sfoderabile. Piedi in PVC.

CND: Y123606

Repertorio: 2176654

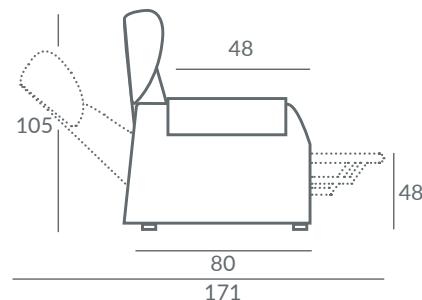
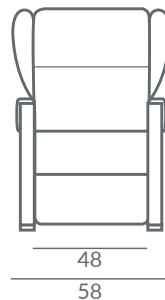

VERSIONE



Meccanica Lift-Relax 1 Motore



Meccanica Lift-Relax 2 Motori

OPTIONAL

Roller System



Kit Batteria
60 Cicli



Doppia Tavoletta

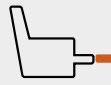

Zero Gravity



Copripoltrone



Maniglia



VERSIONE



Meccanica Lift-Relax 1 Motore



Meccanica Lift-Relax 2 Motori

OPTIONAL

Roller System



Kit 5 Vibro



Kit Batteria
60 Cicli



Doppia Tavoletta



Zero Gravity

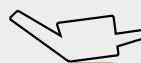

Copripoltrone



Maniglia





HEVEN

dispositivo medico

Poltrona Lift-Relax realizzata con meccanismo motorizzato. La struttura solida è assemblata con parti esterne e interne in agglomerato di legno (multistrato e massello di legno) ricoperta da poliuretano espanso indeformabile. Rivestimento in Tessuto/ Ecopelle/Pelle. Non sfoderabile. Piedi in PVC.

CND: Y123606

Repertorio: 2176656



BONTON

dispositivo medico

Poltrona Lift-Relax realizzata con meccanismo motorizzato. La struttura solida è assemblata con parti esterne e interne in agglomerato di legno (multistrato e massello di legno) ricoperta da poliuretano espanso indeformabile. Rivestimento in Tessuto/ Ecopelle/Pelle. Non sfoderabile. Piedi in PVC.

CND: Y123606

Repertorio: 2176651

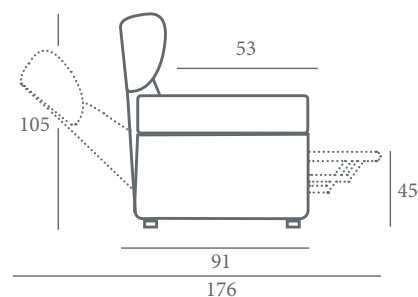
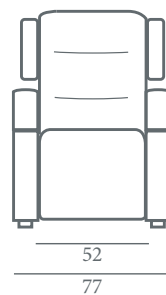
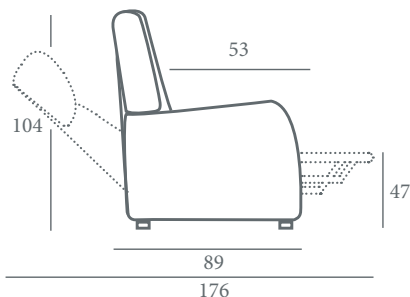
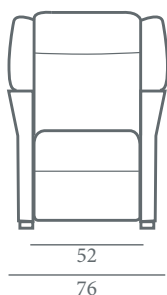

VERSIONE



Meccanica Lift-Relax 1 Motore



Meccanica Lift-Relax 2 Motori

OPTIONAL

Roller System



Kit 5 Vibro



Kit Batteria 60 Cicli



Doppia Tavoletta

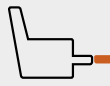

Zero Gravity



Copripoltrone



Maniglione



BF 15



VERSIONE



Meccanica Lift-Relax 1 Motore



Meccanica Lift-Relax 2 Motori

OPTIONAL

Roller System



Kit 5 Vibro



Kit Batteria 60 Cicli



Doppia Tavoletta



Copripoltrone



Maniglione



Braccioli estraibili di serie



Tavolino



Orecchie Estraibili di serie



4 ruote piroettanti



A series of 20 horizontal dotted lines spanning the width of the page, intended for writing or drawing.



Copyright Intermed Srl

Tutti i diritti sono riservati. È vietata la riproduzione anche parziale dell'opera, in ogni forma e con ogni mezzo, senza l'autorizzazione del possessore dei diritti.

L'azienda anche senza preavviso, si riserva di apportare tutte le modifiche che riterrà opportune al fine di migliorare la qualità e le prestazioni dei propri prodotti.

L'azienda declina ogni responsabilità per errori di stampa, omissioni, errate indicazioni e descrizioni o altri errori incorsi con la realizzazione del catalogo.

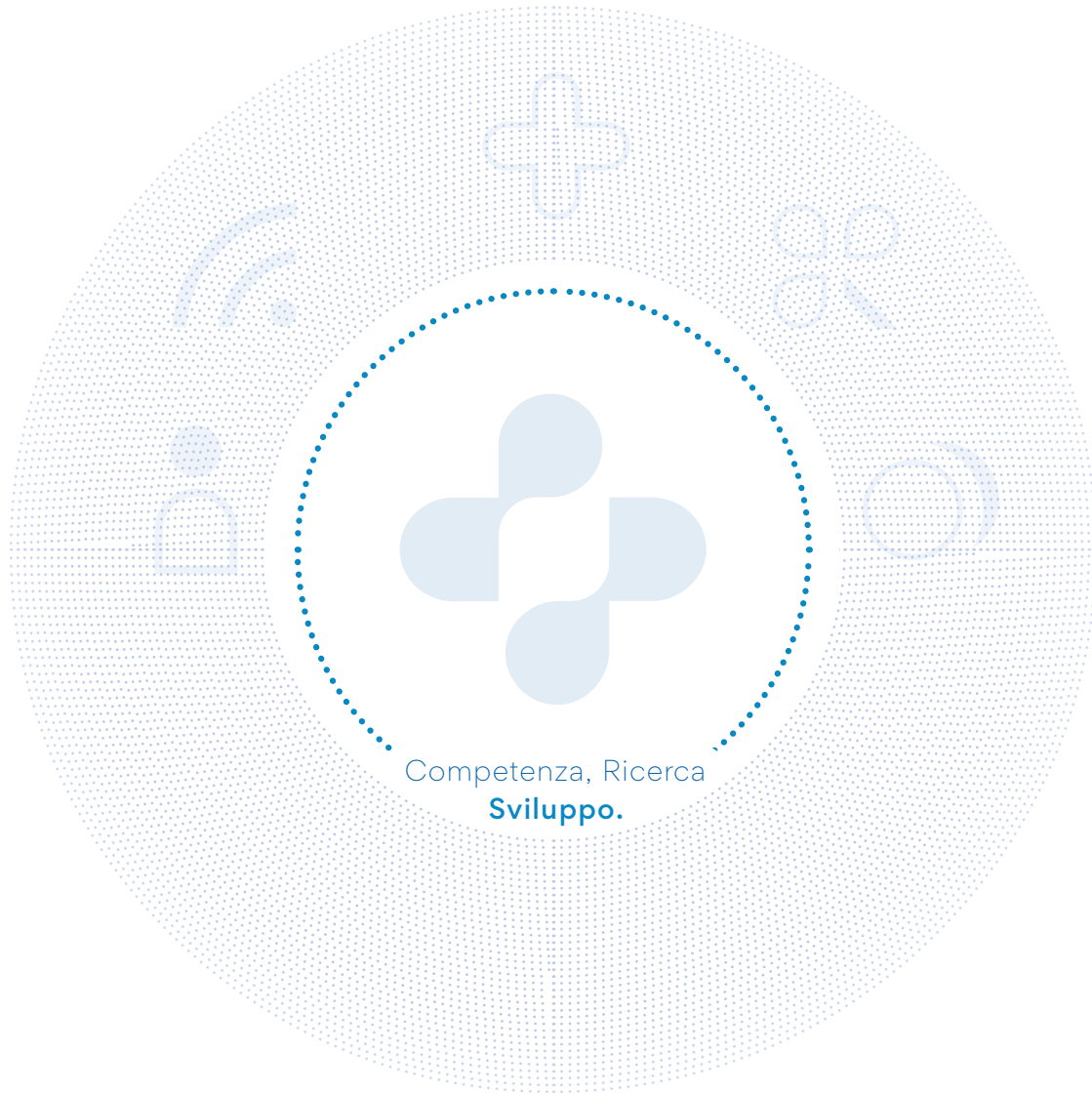

Competenza, Ricerca
Sviluppo.

INTERMED S.R.L.

via Ludovico d'Aragona, 11 - 20132 Milano (MI)
tel. +39 02.98248016 - fax +39 02.98247361
info@intermeditalia.it - www.intermeditalia.it



00176637