

infiniti

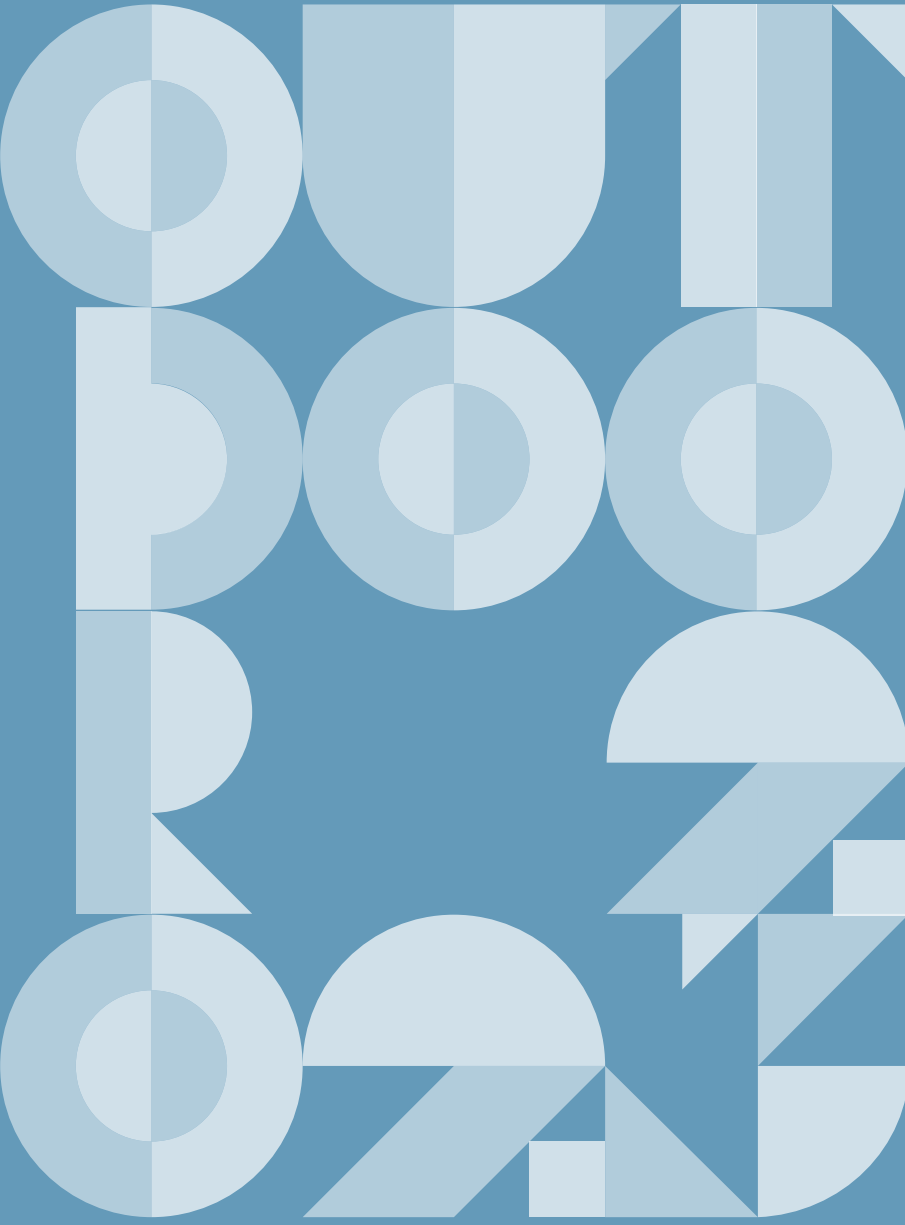

Outdoor Collections 2023

An outdoor journey into Design

UN VIAGGIO "OUTDOOR" NEL DESIGN

Every project is a journey, and every journey is a project.

Physical and mental paths that intersect and meet to generate emotions, stories and experiences.

Starting from what we love to do, in this collection dedicated to outdoor products, we have told a series of endless projects conceived or adapted for outdoor use, through an adventurous journey in the typical Italian regions; from plants that grow wild, to annual temperatures, to the local proverbs, we wanted to merge our product with the architecture and materials characteristic of the various areas of Italy, from north to south or from East to West. And we have not given an order to our journey because there is no order, every Italian region is a microcosm, every project is a journey and every journey is a project.

We have experimented with new shapes but above all with new finishes and materials so that the product could lend itself to the demanding requirements of the 'plein-air', combining the contemporary design of our products with glimpses of historical architecture, breath taking views and modern elements.

Enjoy your journey!

Ogni progetto è un viaggio e ogni viaggio è un progetto.

Percorsi fisici e mentali che si intersecano e si incontrano per generare emozioni, racconti ed esperienze.

Partendo da ciò che amiamo fare, in questa raccolta dedicata ai prodotti outdoor, abbiamo raccontato una serie di progetti infiniti concepiti o adattati all'uso in esterno, attraverso un avventuroso viaggio nelle tipicità regionali italiane; dalle piante che crescono spontanee, alle temperature annue, ai proverbi locali, abbiamo voluto fondere il nostro prodotto con le architetture e i materiali caratteristici delle varie aree d'Italia, da nord a sud e da est ad ovest. E non abbiamo dato un ordine al nostro viaggio perché non esiste un ordine, ogni regione italiana è un microcosmo, ogni progetto è un viaggio e ogni viaggio è un progetto.

Abbiamo sperimentato nuove forme ma soprattutto nuove finiture e materiali perché il prodotto potesse prestarsi alle esigenti richieste del 'plein-air', accostando il design contemporaneo dei nostri prodotti a scorci di architettura storica, viste mozzafiato ed elementi moderni.

Buon Viaggio!

Index

INDICE

SICILY -----	8	APULIA -----	74
Tondina Slim Ipe		Fiorellina Join Table	
BASILICATA -----	14	CAMPANIA -----	80
Tondina Slim Loop Table		Drop Drop Table	
LOMBARDY -----	20	PIEDMONT -----	86
Tondina Pop		Flink	
SARDINIA -----	26	CALABRIA -----	92
Ruelle Ruelle Table		Round & Round	
MARCHE -----	32	LIGURIA -----	98
Úti Line Table		Klejn Faro	
VENETO -----	38	TRENTINO-SOUTH TYROL -----	104
Loop Mono Loop table		Pure Loop Mini	
LAZIO -----	44	EMILIA ROMAGNA -----	110
Pure Loop Mono Record Contract		Sys	
UMBRIA -----	50	AOSTA VALLEY -----	116
Canova Feluca Table		Demoiselle	
ABRUZZI -----	56	FRIULI VENICE JULIA -----	122
Feluca Pop Feluca Table		Record Bench Record Living	
MOLISE -----	62	SAN MARINO REPUBLIC -----	128
Feluca Pop Feluca Table		Jit Table Tondina Slim Tondina Pop	
TUSCANY -----	68		
Next Line Table		TECHNICAL DRAWINGS / DISEGNI TECNICI ----	134
		FINISHES / FINITURE -----	144

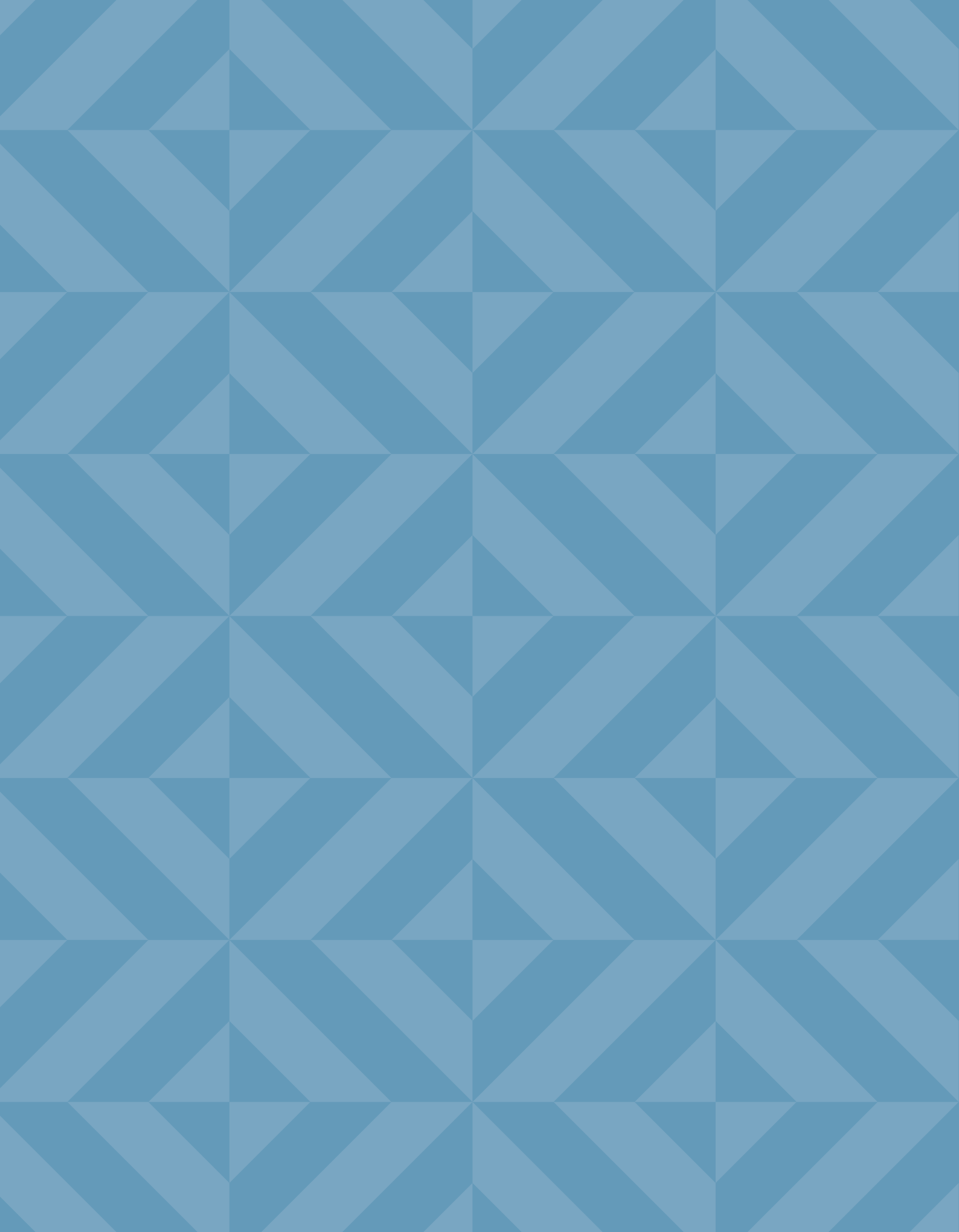

Outdoor Collections

COLLEZIONI OUTDOOR



REGIONS OF ITALY
Regioni d'Italia

 **REGION CAPITAL**
Capoluogo
Palermo

 **COORDINATES**
Coordinate
37°35'59.85"N
14°00'55.36"E

 **LOCAL PROVERB**
Proverbio locale

Quannu è annuvulatu a la marina pigghiti 'u saccu, v`a e macina. Quannu è annuvulatu a la montagna, pigghiti 'a zappa, v`a e guadagna.

If clouds come from the sea, don't go to work because it will rain. If clouds come from the mountains, go to work, it won't rain.

Se le nuvole arrivano dal mare, non andare al lavoro perchè pioverà. Se arrivano nubi dalla montagna vai al lavoro, non pioverà.

 **REGION CAPITAL TEMPERATURES**
Temperature del capoluogo

 **SUMMER AVERAGE**
Media estiva
25°C

 **WINTER AVERAGE**
Media invernale
13°C

 **MM OF RAIN PER YEAR**
mm di pioggia all'anno
615 mm

 **ORANGE TREE**
Arancio
Citrus X sinensis

Tondina Slim

GOES TO SICILY



Tondina Slim

DESIGN
FAVARETTO&PARTNERS

Frame/Telaio: 31-E Black steel /
Acciaio nero

**Seat and Backrest/Seduta e
Schienale:** P557C Light green
polypropylene / Polipropilene
verde acqua

Ipe

DESIGN
ARTER&CITTON

Frame/Telaio: 03 Black steel /
Acciaio nero

Table top/Piano tavolo: 03
Black steel / Acciaio nero





Tondina Slim

Outdoor finishes / Finiture Outdoor

Tondina Slim

Tradition and innovation come together in Tondina Slim, a chair with or without armrests designed by Favaretto&Partners. The latest addition to the Tondina family is distinguished by an unmistakable openwork texture, which recalls the traditional weave of the 1950s reinterpreted in a more contemporary version. A painted rod frame and a wide range of colours for the micro-perforated seat and backrest make Tondina Slim an ideal chair for furnishing outdoor spaces with harmony.

Tradizione e innovazione confluiscono in Tondina Slim, una sedia con o senza braccioli disegnata da Favaretto&Partners. L'ultima nata della famiglia Tondina è contraddistinta da una inconfondibile texture traforata, che rimanda alla trama tradizionale degli anni '50 reinterpreta in una versione più contemporanea. Grazie ad un telaio in tondino verniciato ed un'ampia palette colori del sedile e dello schienale microforati, Tondina Slim diventa una seduta ideale per arredare con armonia gli ambienti esterni.

FRAME / TELAIO

Steel / Acciaio

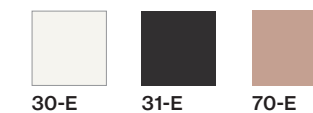

SEAT AND BACKREST / SEDUTA E SCHIENALE

Post Consumer Industrial Plastic / Polipropilene Post Consumo Industriale



Polypropylene / Polipropilene



Ipe

Ipe is a coffee table with round or square top, available in two different heights, suitable for an outdoor use. The cast iron base supports its characteristic wiredrawn structure in steel. A design with a vintage flavour for contract environments, such as pubs and restaurants.

Tavolino con piano tondo o quadro disponibile in due altezze, adatto all'outdoor. La base in ghisa sorregge la caratteristica struttura a trave trafilata in ferro. Un design dal sapore vintage per contesti contract come locali e ristoranti.

FRAME / TELAIO

Steel / Acciaio



TABLE TOP / PIANO TAVOLO

Polypropylene / Polipropilene



HPL (Black core edge/Bordo anima nera)



Fenix



Steel / Acciaio

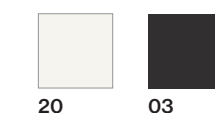

REGIONS OF ITALY
Regioni d'Italia

Tondina Slim with arms

GOES TO BASILICATA

 **REGION CAPITAL**
Capoluogo
Potenza

 **COORDINATES**
Coordinate
40°38'21"N
15°48'19"E

 **LOCAL PROVERB**
Proverbio locale

**Ariu chiaru non
ha paura di troni.**

Clear air, no fear of thunder.
Aria limpida non teme tuoni.

 **REGION CAPITAL
TEMPERATURES**
Temperature del capoluogo

 **SUMMER AVERAGE**
Media estiva
20,3°C

 **WINTER AVERAGE**
Media invernale
5,3°C

 **MM OF RAIN PER YEAR**
mm di pioggia all'anno
82 mm



 **CAROB**
Carrubo
Ceratonia siliqua

Tondina Slim

DESIGN
FAVARETTO&PARTNERS

Frame/Telaio: 30-E White steel /
Acciaio bianco
**Seat and Backrest / Seduta
e Schienale:** R1034 Peach
polypropylene / Polipropilene
pesca

Loop Table

DESIGN
CLAUS BREINHOLT

Frame/Telaio: 20 White painted
aluminium / Alluminio tinto bianco
Table top/Piano tavolo: HPL03
White / Bianco





Tondina Slim with arms, Loop Table

Outdoor finishes / Finiture Outdoor

Tondina Slim

Tradition and innovation come together in Tondina Slim, a chair with or without armrests designed by Favaretto&Partners. The latest addition to the Tondina family is distinguished by an unmistakable openwork texture, which recalls the traditional weave of the 1950s reinterpreted in a more contemporary version. A painted rod frame and a wide range of colours for the micro-perforated seat and backrest make Tondina Slim an ideal chair for furnishing outdoor spaces with harmony.

Tradizione e innovazione confluiscono in Tondina Slim, una sedia con o senza braccioli disegnata da Favaretto&Partners. L'ultima nata della famiglia Tondina è contraddistinta da una inconfondibile texture traforata, che rimanda alla trama tradizionale degli anni '50 reinterpreta in una versione più contemporanea. Grazie ad un telaio in tondino verniciato ed un'ampia palette colori del sedile e dello schienale microforati, Tondina Slim diventa una seduta ideale per arredare con armonia gli ambienti esterni.

FRAME / TELAIO

Steel / Acciaio

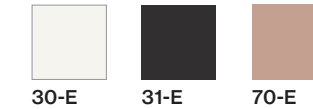

SEAT AND BACKREST / SEDUTA E SCHIENALE

Post Consumer Industrial Plastic / Polipropilene Post Consumo Industriale



Polypropylene / Polipropilene



Loop Table

A table version becomes part of the Loop family, perfect for the contract sector. Loop table is composed of an aluminum base, that supports square or round tops. Available in three fixed heights, the table complements every chair and, thanks to its minimalist design, harmoniously interacts with all the colours of the sky.

Entra nella famiglia Loop una versione tavolo, perfetta per il contract. Loop table è composto da una base in alluminio che sostiene piani quadri o tondi. Su tre altezze fisse, il tavolo completa ogni seduta e grazie al disegno minimale dialoga allegramente con ogni colore del cielo.

FRAME / TELAIO

Aluminium / Alluminio

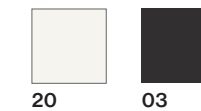
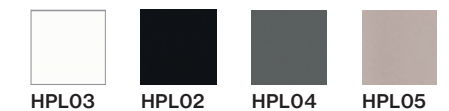

TABLE TOP / PIANO TAVOLO

Polypropylene / Polipropilene



HPL (Black core edge/Bordo anima nera)



Fenix

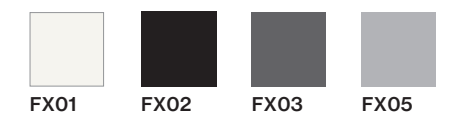

REGIONS OF ITALY
Regioni d'Italia

Tondina Pop
GOES TO LOMBARDY

 **REGION CAPITAL**
Capoluogo
Milano

 **COORDINATES**
Coordinate
45°35'08"N
9°55'49"E

 **LOCAL PROVERB**
Proverbio locale

**Quant böta la igna
èn Mars dè sicür
vè piè i tinàs.**

When the vines sprout
in March be sure you will
surely fill the vats.

*Quando germoglia la vite a
Marzo di sicuro riempi i tini.*

 **REGION CAPITAL
TEMPERATURES**
Temperature del capoluogo

 **SUMMER AVERAGE**
Media estiva
23,1°C

 **WINTER AVERAGE**
Media invernale
5,7°C

 **MM OF RAIN PER YEAR**
mm di pioggia all'anno
945 mm



 **ACACIA**
Acacia
Acacia

Tondina Pop

DESIGN
FAVARETTO&PARTNERS

Frame/Telaio: 31-E Black steel /
Acciaio Nero

**Seat and backrest/Seduta e
schienale:** P7608U Marsala
polypropylene; R1034 Peach
polypropylene; R8022 Black
polypropylene / Polipropilene
Marsala; Polipropilene Pesca;
Polipropilene Nero





Tondina Pop

Outdoor finishes / Finiture Outdoor

Tondina Pop

Inspired by the wooden version, Tondina Pop furnishes every environment with style thanks to the coloured plastic panels and frame. The chair is inspired by the rigor of Nordic design and it is composed of a seat and a back in coloured polypropylene and a light structure in steel rod. Thanks to the round shapes and to the wide range of solutions available, Tondina Pop is suited as a bar, a restaurant, a bistrot and a dining room chair. It is also suitable for outdoor areas.

Nata dalla versione in legno, Tondina Pop arreda ogni ambiente con stile grazie ai pannelli in plastica e al telaio colorato. Seduta ispirata allo stile nordico, composta da pannelli seduta e schienale in polipropilene colorato e una delicata struttura in tondino. Grazie alle forme arrotondate e all'ampia gamma di soluzioni disponibili Tondina è adatta come sedia da bar, ristorante, bistrot, e anche per sala da pranzo e spazi esterni.

FRAME / TELAIO

Steel / Acciaio



30-E



31-E



70-E

SEAT AND BACKREST / SEDUTA E SCHIENALE

Polypropylene / Polipropilene



S020



R8022



P421C



P480C



P557C



P7608U



R1034

REGIONS OF ITALY
Regioni d'Italia

 **REGION CAPITAL**
Capoluogo
Cagliari

 **COORDINATES**
Coordinate
39°13'09.12"N
9°07'01.99"E

 **LOCAL PROVERB**
Proverbio locale

**Abba de sero,
friscu de
manzanu.**

If it rains in the evening, there
will be fresh weather in the
morning.

*Acqua di sera, fresco la
mattina.*

 **REGION CAPITAL
TEMPERATURES**
Temperature del capoluogo

 **SUMMER AVERAGE**
Media estiva
24,4°C

 **WINTER AVERAGE**
Media invernale
11°C

 **MM OF RAIN PER YEAR**
mm di pioggia all'anno
448 mm

Ruelle
GOES TO SARDINIA



 **MYRTLE**
Mirto
Myrtus communis



Ruelle

DESIGN
PHILIPPE TABET

Frame/Telaio: 43 Aquamarine blue fine textured aluminium / Alluminio acquamarina fine texture

Backrest/Schienale: S503 Powder blue polypropylene / Polipropilene azzurro polvere

Ruelle Table

DESIGN
PHILIPPE TABET

Frame/Telaio: 20 Embossed white steel / Acciaio bianco gofrato

Table top/Piano tavolo: MRM01 Marble / Marmo



Ruelle Outdoor, Ruelle Table

Outdoor finishes / Finiture Outdoor

Ruelle

In the small alleyways of the small French country villages (the so-called "ruelles") is typical having a seat on the traditional bistrot and brasserie chairs, which have been revisited by Philippe Tabet in a contemporary way. Ruelle won the fourth edition of the design Contest of Infiniti. It is a chair with a die-cast aluminium structure and extruded aluminium legs. Thanks to the coloured polypropylene backrest and to the perforated seat, Ruelle outdoor is water-resistant and can be used for bars and restaurants with an outdoor patio.

Nei piccoli vicoli dei paesini francesi di campagna ("ruelle", appunto) è tipico sedersi nelle classiche sedie da bistrot e brasserie, che Philippe Tabet ha rielaborato in chiave contemporanea. Ruelle ha vinto la quarta edizione del Contest di design di Infiniti. Ruelle è una sedia con una struttura in alluminio pressofuso, e gambe in alluminio estruso. Grazie allo schienale in polipropilene colorato e alla seduta forata, Ruelle outdoor non teme la pioggia e può essere utilizzata come seduta da bar e bistrò con dehors all'aperto.

FRAME / TELAIO

Aluminium / Alluminio



20



3009F



7035F



43



26



7016F



03

BACKREST / SCHIENALE

Plywood Oak / Rovere multistrato



ROVFN



ROTP04

Polypropylene / Polipropilene



S020



P7608U



R7015



S021



S503

UPHOLSTERY / TAPPEZZERIA

B-CHEW TRIO ABITEX
MIAMI PINTAIL

Ruelle Table

To complete the Ruelle chair family, inspired by the ones layed outside the French bistros, infiniti presents the homonymous coffee table, with a central system that rests on a linear three-legged structure in die-cast aluminum. Ideal for bars and outdoor contexts, Ruelle tables have as an option the tip-up top, useful for solving space needs. Available table heights: 710mm/1070 mm.

A completamento della famiglia della sedia Ruelle, ispirata alle sedute dei bistrot francesi, infiniti presenta l'omonimo tavolino, con fusto centrale che poggia su una struttura lineare a tre gambe in alluminio pressofuso. Ideale per bar e contesti outdoor, il tavolo Ruelle aggiunge come opzione la possibilità di avere il piano ribaltabile, utile per risolvere necessità di spazio. Altezze disponibili: 710 mm/1070 mm.

FRAME / TELAIO

Steel / Acciaio



20



03



7016F

TABLE TOP / PIANO TAVOLO

HPL (Black core edge/Bordo anima nera)



HPL03



HPL02



HPL04



HPL05

Fenix



FX01



FX02



FX03



FX05

Steel / Acciaio



20



03



7016F

Recycled Fibreglass



RFS01

Marble / Marmo



MRM01



MRM02

REGIONS OF ITALY
Regioni d'Italia

 **REGION CAPITAL**
Capoluogo
Ancona

 **COORDINATES**
Coordinate
43°37'00"N
13°31'00"E

 **LOCAL PROVERB**
Proverbio locale

**Se li gljorni de la merla
voli passà, pane, pulenta,
porcu e focu a volontà!**

If you want to have a good time on the coldest days of the year, take your bread, polenta and pork and sit by the fireplace to warm yourself.

Se i giorni della merla, quelli più freddi dell'anno, vuoi passare bene, prendi pane polenta e maiale e mettiti vicino al camino a riscaldarti.

 **REGION CAPITAL TEMPERATURES**
Temperature del capoluogo

 **SUMMER AVERAGE**
Media estiva
22,3°C

 **WINTER AVERAGE**
Media invernale
7,1°C

 **MM OF RAIN PER YEAR**
mm di pioggia all'anno
83 mm

 **BEECH TREE**
Faggio
Fagus

Úti e Úti Rope

GO TO MARCHE



Úti

DESIGN
MC.DSG

Frame/Telaio: 1032F-E Broom
yellow steel / Acciaio giallo
ginestra

Backrest/schienale: R1012
Mustard polypropylene /
Polipropilene senape

Line Table

DESIGN
BROGLIATOTRAVERSO

Frame/Telaio: 20 White steel /
Acciaio bianco

Table top/Piano tavolo: 20 White
steel / Acciaio bianco





Úti Rope, Line Table

Outdoor finishes / Finiture Outdoor

Úti

"Úti" is the Icelandic word that expresses the French concept of "en plein air". With this chair, infiniti gives a new, nordic and minimal, direction to the outdoor furniture, overcoming the common Mediterranean-inspired dehors concept. Úti is a chair with a structure manufactured in painted steel rod, available with or without arms. The back and the seat are perforated, but for a greater comfort an outdoor fabric removable seat panel is available. Úti is ideal for an outdoor use.

"Úti" è la parola con cui in islandese si indica il concetto di "en plen air": con questa seduta infiniti intende dare una nuova direzione all'arredo outdoor, più nordico e minimale, che supera il più comune concetto dehors di ispirazione mediterranea. Úti è una sedia con una struttura in tondino d'acciaio verniciato, con o senza braccioli, perfetta per ambienti esterni. Il sedile e la seduta sono forati, ma per un maggiore confort è disponibile un pannellino seduta removibile con tessuto outdoor.

FRAME / TELAIO

Steel / Acciaio

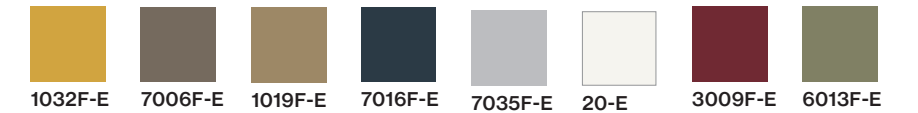

BACKREST / SCHIENALE

Polypropylene / Polipropilene



Miami Pintail cushion / Cuscino tappezzato Miami Pintail

Úti Rope

La nuova versione Rope si veste di un mood mediterraneo, con un omaggio che ricorda il Bel Paese: il telaio in ferro verniciato si riveste di un elegante e fitto reticolo di corda, disponibile in diversi colori, che può avvolgere solo la seduta o anche lo schienale. Úti Rope è disponibile con o senza braccioli, e il suo confort viene amplificato dalla tensione degli intrecci della corda, che è impermeabile e utilizzabile nei contesti outdoor.

The new Rope version takes on a Mediterranean mood, with a tribute reminiscent of the Bel Paese: the painted iron frame is covered with an elegant and dense network of nautical rope, available in different colours, which can wrap around just the seat or also the backrest. Úti Rope is available with or without armrests, and its comfort is amplified by the tension of the rope weaves, which are waterproof and can be used in outdoor contexts

FRAME / TELAIO

Steel / Acciaio

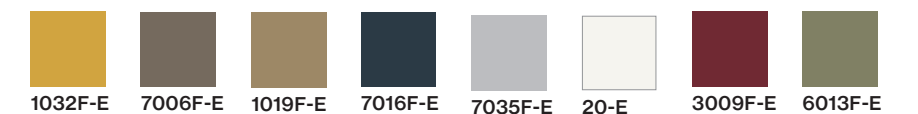

SEAT AND BACKREST / SEDUTA E SCHIENALE

Nautical Rope / Corda Marina



REGIONS OF ITALY
Regioni d'Italia

 **REGION CAPITAL**
Capoluogo
Venezia

 **COORDINATES**
Coordinate
45°26'23"N
12°19'55"E

 **LOCAL PROVERB**
Proverbio locale

Da la Madonna Candeòra
de l'inverno semo fora;
ma se xe piova e vento,
de l'inverno semo drento.

The day we celebrate Madonna
of Candlemas, we can say we are
almost out of winter.

*Madonna della Candelora siamo
fuori dall'inverno; ma se piove o c'è
vento, siamo ancora in inverno.*

 **REGION CAPITAL
TEMPERATURES**
Temperature del capoluogo

 **SUMMER AVERAGE**
Media estiva
22,3°C

 **WINTER AVERAGE**
Media invernale
5,7°C

 **MM OF RAIN PER YEAR**
mm di pioggia all'anno
750 mm

Loop Mono

GOES TO VENETO



 **DANDELION**
Tarassaco
Taraxacum officinale

Loop Mono

4LEGS NON
STACKABLE

DESIGN
CLAUS BREINHOLT

Frame/Telaio: 514F-E Sand steel
/ Acciaio sabbia

Shell/Scocca: IP7608U Marsala
post consumer industrial plastic /
Plastica post consumo industriale
marsala

Loop table

DESIGN
CLAUS BREINHOLT

Frame/Telaio: 20 White painted
aluminium / Alluminio tinto bianco

Table top/Piano tavolo: FX01
White fenix / Fenix bianco





Loop Mono, Loop Table

Outdoor finishes / Finiture Outdoor

Loop Mono

It was born ten years ago, and it has immediately become one of the infiniti best sellers. Loop is a sinuous icon capable of making any public or private environment elegant. The polycarbonate shell gives now way to a recycled polypropylene version, made even thinner and lighter than before. The ergonomic armrests have a new size, but maintaining the typical curvature, which has made this chair unique for its kind. Loop Mono in polypropylene, which is added to the classic wooden version, takes on a pop, fresh and modern connotation.

Nata dieci anni fa e divenuta sin da subito uno dei best sellers infiniti, Loop è un'icona sinuosa e capace di rendere elegante ogni ambiente pubblico o privato. La scocca in policarbonato lascia ora il posto alla versione in polipropilene riciclato, resa ancora più sottile e leggera. I braccioli ergonomici presentano una nuova misura, mantenendo la tipica curvatura che hanno reso questa sedia unica nel suo genere. Loop in polipropilene, che si aggiunge alla classica versione in legno, assume una connotazione pop, attuale e moderna.

FRAME / TELAIO

Steel / Acciaio

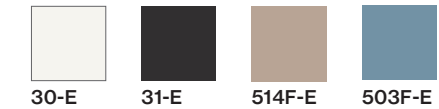

SHELL / SCOCCA

Post Consumer Industrial Plastic / Polipropilene Post Consumo Industriale



Polypropylene / Polipropilene

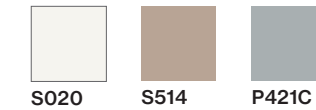

Loop Table

A table version becomes part of the Loop family, perfect for the contract sector. Loop table is composed of an aluminum base, that supports square or round tops. Available in three fixed heights, the table complements every chair and, thanks to its minimalist design, harmoniously interacts with all the colours of the sky.

Entra nella famiglia Loop una versione tavolo, perfetta per il contract. Loop table è composto da una base in alluminio che sostiene piani quadrati o tondi. Su tre altezze fisse, il tavolo completa ogni seduta e grazie al disegno minimale dialoga allegramente con ogni colore del cielo.

FRAME / TELAIO

Aluminium / Alluminio

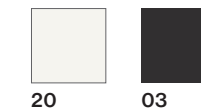
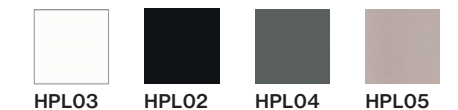

TABLE TOP / PIANO TAVOLO

Polypropylene / Polipropilene



HPL (Black core edge/Bordo anima nera)



Fenix

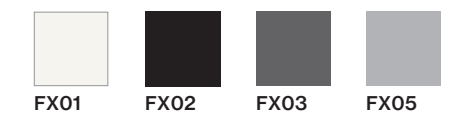

REGIONS OF ITALY
Regioni d'Italia

 **REGION CAPITAL**
Capoluogo
Roma

 **COORDINATES**
Coordinate
41°44'35"N
104°28'58"E

 **LOCAL PROVERB**
Proverbio locale

**Massèra ce ne
iàmo a pranzà alla
faccia de chi vò
male!**

Let's eat in the face of
those who wish us evil!

*Mangiamo alla faccia di chi
ci vuole del male!*

 **REGION CAPITAL
TEMPERATURES**
Temperature del capoluogo

 **SUMMER AVERAGE**
Media estiva
23,6°C

 **WINTER AVERAGE**
Media invernale
8,9°C

 **MM OF RAIN PER YEAR**
mm di pioggia all'anno
795 mm

Pure Loop Mono

GOES TO LAZIO



 **ARTICHOKE**
Carciofo
Cynara cardunculus

Pure Loop Mono

4LEGS NON
STACKABLE

DESIGN
CLAUS BREINHOLT

Frame/Telaio: 30-E Matt white steel / Acciaio bianco opaco
Shell/Scocca: P421C
Almond grey polypropylene / Polipropilene grigio mandorla

Record Contract

DESIGN
MC.DSG

Frame/Telaio: 03 Black steel / Acciaio nero
Table top/Piano tavolo: HPL02
Black / Nero





Record Contract

Outdoor finishes / Finiture Outdoor

Pure Loop Mono

The latest evolution of the Pure Loop series, 'Mono' is a shell that can be matched with any existing frame or base of the family. The shell is a coloured, recycled polypropylene monocoque which can be defined as extremely versatile. The painted steel frames make it ideal for furnishing environments including outdoor areas.

L'ultima evoluzione della serie Pure Loop, "Mono" è una monoscocca in grado di abbinarsi a tutte le basi della gamma Pure Loop. Pure Loop Mono è un monoscocca in polipropilene colorato e riciclato, estremamente versatile. I telai in acciaio verniciato rendono ideale per arredare tutti gli ambienti, anche quelli esterni.

FRAME / TELAIO

Steel / Acciaio

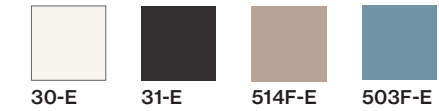

SHELL / SCOCCA

Post Consumer Industrial Plastic / Polipropilene Post Consumo Industriale

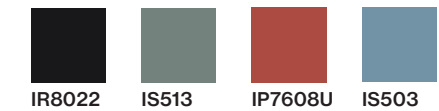

Polypropylene / Polipropilene



Record Contract

Record is an innovative design table, which combines style and versatility through the intersection of simple lines. Legs and footrest intersect without screws, giving an impressive and appealing attention to the details. It fits perfectly in bars, restaurants and bistros and it is available in three heights. The wide range of tops makes Record Contract the perfect coffee table for several furnishing situations.

Record è un innovativo tavolo di design, che combina stile e versatilità attraverso l'unione di linee semplici. Gambe e poggiatesta si intersecano senza la necessità di viti, dando un tocco suggestivo ed elegante ai dettagli. Tavolo per bar, ristoranti e bistrot disponibile in tre altezze. La numerosa scelta di piani disponibili fa di Record Contract il tavolo perfetto per molteplici situazioni di arredo.

FRAME / TELAIO

Steel / Acciaio

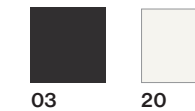

TABLE TOP / PIANO TAVOLO

Polypropylene / Polipropilene



HPL (Black core edge/Bordo anima nera)



Fenix



Steel / Acciaio

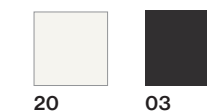

Recycled Fibreglass

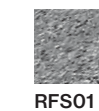

REGIONS OF ITALY
Regioni d'Italia

 **REGION CAPITAL**
Capoluogo
Perugia

 **COORDINATES**
Coordinate
42°59'N
12°34'E

 **LOCAL PROVERB**
Proverbio locale

Gimo che è bulo.

Let's go, it's nice.

Andiamo, che è bello.

 **REGION CAPITAL TEMPERATURES**
Temperature del capoluogo

 **SUMMER AVERAGE**
Media estiva
22,3°C

 **WINTER AVERAGE**
Media invernale
6,8°C

 **MM OF RAIN PER YEAR**
mm di pioggia all'anno
86 mm

Canova
GOES TO UMBRIA



 **WILD THYME**
Timo selvatico
Thymus serpyllum

Canova

DESIGN
CLAUS BREINHOLT

MONOBLOC / MONOSCOCCA:
IP7608U Marsala polypropylene /
Polipropilene Marsala
Upholstery/Tapezzeria: Miami
7746

Feluca Table

DESIGN
BROGLIATOTRAVERSO

Frame/Telaio: 03 Black
embossed aluminium / Alluminio
nero gofrato
Table top/Piano tavolo: MRM02
Black marquina marble / Marmo
Nero Marquina





Canova, Feluca Table

Outdoor finishes / Finiture Outdoor

Canova

Canova is a chair with a classic clean design. Soft colours and round shapes enhance the framework material. It's a monobloc chair in polypropylene with an upholstered seat cushion for indoor or outdoor, reminding of a vintage wooden chair, but realised with a fresh and contemporary touch.

Canova è una seduta dal design classico e pulito. I colori tenui e le forme arrotondate nobilitano il materiale della sua struttura. Sedia monoblocco in polipropilene dotata di cuscino imbottito sia da interno che da esterno, ricorda una sedia di legno vintage, ma realizzata con un tocco fresco e contemporaneo.

MONOBLOC / MONOSCOCCA

Post Consumer Industrial Plastic / Polipropilene Post Consumo Industriale

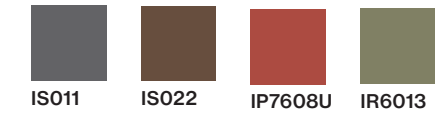

Polypropylene / Polipropilene

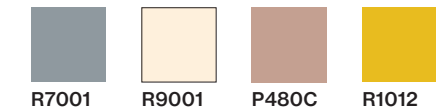

UPHOLSTERY / TAPPEZZERIA

B-CHEW TRIO ABITEX
MIAMI PINTAIL

Feluca Table

In addition to the Feluca Family, a line of coffee tables with a simple and practical design is introduced. It is available in two versions with 4 legs and round top. They find their perfect location in any horeca environment. Heights: 710mm/1070 mm.

Alla gamma Feluca si aggiunge una linea di tavolini dal design semplice e pratico. Due le versioni disponibili, con 4 gambe e piano tondo. Trovano la loro perfetta collocazione in qualsiasi ambiente horeca. Altezze: 710 mm/1070 mm.

FRAME / TELAIO

Steel / Acciaio

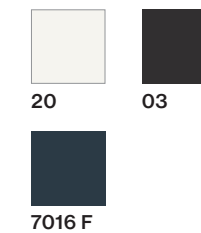
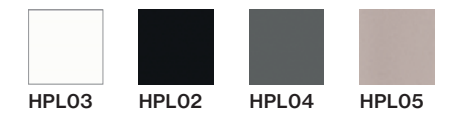
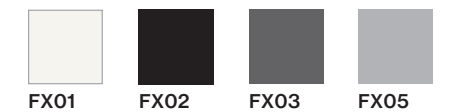

TABLE TOP / PIANO TAVOLO

HPL (Black core edge/Bordo anima nera)



Fenix



Steel / Acciaio



Recycled Fibreglass

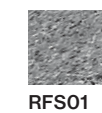

Marble / Marmo

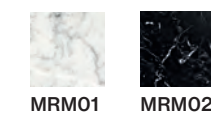

REGIONS OF ITALY
Regioni d'Italia

 **REGION CAPITAL**
Capoluogo
L'Aquila

 **COORDINATES**
Coordinate
42°21'14.43"N
13°23'31.17"E

 **LOCAL PROVERB**
Proverbio locale

**La parol' chi ni si
dic' è sempr'
la cchiu' meij!**

Sometimes it is better
to keep silent.

*La parola non detta
è sempre la migliore.*

 **REGION CAPITAL
TEMPERATURES**
Temperature del capoluogo

 **SUMMER AVERAGE**
Media estiva
20°C

 **WINTER AVERAGE**
Media invernale
4,1°C

 **MM OF RAIN PER YEAR**
mm di pioggia all'anno
705 mm

Feluca Pop

GOES TO ABRUZZI



 **LADY'S SLIPPER**
Scarpette di Venere
Cypripedium calceolus

Feluca Pop

DESIGN
BROGLIATOTRAVERSO

Frame/Telaio: 20-E White steel / Acciaio bianco; 79-E Ochre yellow steel / Acciaio giallo ocra; 78-E Coral red steel / Acciaio rosso corallo

Seat and backrest/seduta e schienale: S020 White polypropylene / Polipropilene bianco; S529 Ochre yellow polypropylene / Polipropilene giallo ocra; S527 Coral red polypropylene / Polipropilene rosso corallo

Feluca Table

DESIGN
BROGLIATOTRAVERSO

Frame/Telaio: 03 Black steel / Acciaio Nero

Table top/Piano tavolo: RFS01 Recycled fiberglass / Fibra rigenerata





Feluca Pop, Feluca Table

Outdoor finishes / Finiture Outdoor

Feluca Pop

To the wooden version, presented at the 2019 Salone del Mobile, the Feluca family adds the possibility of having seat and back in recycled polypropylene, both for the chair version and for the new stool, available in kitchen or bar height. Thanks to this new feature, the structure, made of an elliptical tube in painted steel, can create an elegant tone-on-tone effect. Ideal for furnishing with harmony outdoor environments.

Alla versione in legno, presentata al Salone del Mobile 2019, la famiglia Feluca aggiunge la possibilità di avere sedile e schienale in polipropilene riciclato, sia per la versione sedia che per il nuovo sgabello, disponibile in altezza cucina o bar. Grazie a questa novità, la peculiare struttura in tubo ellittico in acciaio verniciato può creare un elegante effetto tono su tono. Ideale per arredare con armonia gli ambienti esterni.

FRAME / TELAIO

Steel / Acciaio

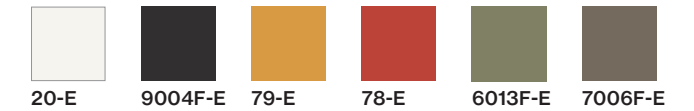

SEAT AND BACKREST / SEDUTA E SCHIENALE

Post Consumer Industrial Plastic / Polipropilene Post Consumo Industriale



Polypropylene / Polipropilene

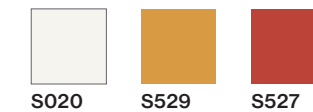

Feluca Table

In addition to the Feluca Family, a line of coffee tables with a simple and practical design is introduced. It is available in two versions with 4 legs and round top. They find their perfect location in any horeca environment. Heights: 710mm/1070 mm.

Alla gamma Feluca si aggiunge una linea di tavolini dal design semplice e pratico. Due le versioni disponibili, con 4 gambe e piano tondo. Trovano la loro perfetta collocazione in qualsiasi ambiente horeca. Altezze: 710 mm/1070 mm.

FRAME / TELAIO

Steel / Acciaio

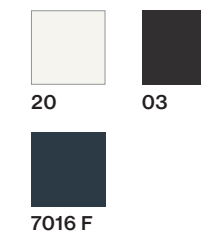
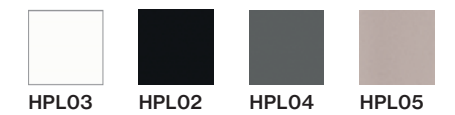
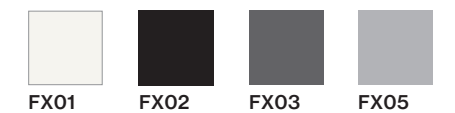

TABLE TOP / PIANO TAVOLO

HPL (Black core edge/Bordo anima nera)



Fenix



Steel / Acciaio



Recycled Fibreglass

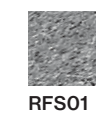

Marble / Marmo



REGIONS OF ITALY
Regioni d'Italia

 **REGION CAPITAL**
Capoluogo
Campobasso

 **COORDINATES**
Coordinate
41°34'N
14°40'E

 **LOCAL PROVERB**
Proverbio locale

Magg viern rattaia.

In May, winter leaves.
A maggio l'inverno se ne va.

 **REGION CAPITAL TEMPERATURES**
Temperature del capoluogo

 **SUMMER AVERAGE**
Media estiva
21°C

 **WINTER AVERAGE**
Media invernale
5,7°C

 **MM OF RAIN PER YEAR**
mm di pioggia all'anno
560

Feluca Pop

GOES TO MOLISE



 **PRIMULA**
Primula
Primula

Feluca Pop

DESIGN
BROGLIATOTRAVERSO

Frame/Telaio: 6013F-E Reed green steel / Acciaio verde canna; 79-E Ochre yellow steel / Acciaio giallo ocra; 7006F-E Dove grey steel / Acciaio tortora

Seat and backrest/seduta e schienale: S529 Ochre yellow polypropylene / Polipropilene giallo ocra; IS022 Tabacco post consumer polypropylene / Polipropilene post consumo tabacco; IR6013 reed green post consumer polypropylene / Polipropilene post consumo verde canna

Feluca Table

DESIGN
BROGLIATOTRAVERSO

Frame/telaio: 7006F Dove grey steel / Acciaio tortora

Table top/Piano tavolo: HPL05 Dove grey / Grigio tortora





Feluca Table, Feluca Pop

Outdoor finishes / Finiture Outdoor

Feluca Pop

To the wooden version, presented at the Salone del Mobile 2019, the Feluca family adds the possibility of having seat and back in recycled polypropylene, both for the chair version and for the new stool, available in kitchen or bar height. Thanks to this new feature, the structure, made of an elliptical tube in painted steel, can create an elegant tone-on-tone effect. Ideal for furnishing outdoor environments with harmony.

Alla versione in legno, presentata al Salone del Mobile 2019, la famiglia Feluca aggiunge la possibilità di avere sedile e schienale in polipropilene riciclato, sia per la versione sedia che per il nuovo sgabello, disponibile in altezza cucina o bar. Grazie a questa novità, la peculiare struttura in tubo ellittico in acciaio verniciato può creare un elegante effetto tono su tono. Ideale per arredare con armonia gli ambienti esterni.

FRAME / TELAIO

Steel / Acciaio

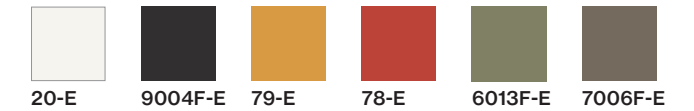

SEAT AND BACKREST / SEDUTA E SCHIENALE

Post Consumer Industrial Plastic / Polipropilene Post Consumo Industriale



Polypropylene / Polipropilene

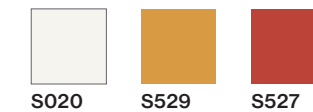

Feluca Table

In addition to the Feluca Family, a line of coffee tables with a simple and practical design is introduced. It is available in two versions with 4 legs and round top. They find their perfect location in any horeca environment. Heights: 710mm/1070 mm.

Alla gamma Feluca si aggiunge una linea di tavolini dal design semplice e pratico. Due le versioni disponibili, con 4 gambe e piano tondo. Trovano la loro perfetta collocazione in qualsiasi ambiente horeca. Altezze: 710 mm/1070 mm.

FRAME / TELAIO

Steel / Acciaio

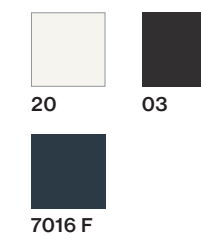
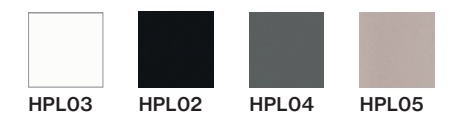

TABLE TOP / PIANO TAVOLO

HPL (Black core edge/Bordo anima nera)



Fenix



Steel / Acciaio



Recycled Fibreglass

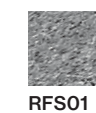

Marble / Marmo



REGIONS OF ITALY
Regioni d'Italia

 **REGION CAPITAL**
Capoluogo
Firenze

 **COORDINATES**
Coordinate
43°46'17"N
11°15'15"E

 **LOCAL PROVERB**
Proverbio locale

**Non ti mettere in
cammino se la
bocca 'un sa di vino.**

Don't walk if your mouth
doesn't taste of wine.

*Non incamminarti se la
bocca non ha sapor di vino.*

 **REGION CAPITAL
TEMPERATURES**
Temperature del capoluogo

 **SUMMER AVERAGE**
Media estiva
23,6°C

 **WINTER AVERAGE**
Media invernale
8°C

 **MM OF RAIN PER YEAR**
mm di pioggia all'anno
870 mm

Next
GOES TO TUSCANY



 **'SANGIOVESE' GRAPEVINE**
Vite sangiovese
Vitis vinifera 'Sangiovese'

Next

DESIGN
ANDREAS OSTWALD

Frame/Telaio: IKTO04 Black painted solid Iroko wood / Massello di legno iroko Tinto nero

Backrest/Schienale: S101 White Polyamide / Poliammide Bianco

Line Table

DESIGN
BROGLIATOTRAVERSO

Frame/Telaio: 7016F Lead grey steel / Grigio piombo

Top Table/Piano Tavolo: HPL04 Anthracite / Antracite





Outdoor finishes / Finiture Outdoor

Next

Plastic, steel and wood: three materials in one sophisticated product, winner of the Good Design Award in 2014. Next finds its ideal place in a modern, minimalist environment. The solid Iroko wood structure and a perforated shell make it a robust chair, suitable for outdoor areas.

Plastica, acciaio e legno: tre materiali in un prodotto sofisticato, vincitore del Good Design Award nel 2014. Next trova il suo posto ideale in un ambiente moderno e minimalista. La solida struttura in legno Iroko e la scocca forata ne fanno una sedia robusta, adatta agli spazi esterni.

FRAME / TELAIO

Solid Iroko wood /
Massello di legno Iroko



IKTO04

SHELL / SCOCCA

Polyamide / Poliammide



S101



S117



S102

Line Table

Practical coffee table with a structure in full drawn and four-star base. The top can be round or square and it is available in different materials. Thin lines create a minimalist and rigorous aesthetic, making Line the perfect table for outdoor spaces.

Pratico tavolino con struttura in trafilato pieno e base a quattro razze. Il piano può essere rotondo o quadrato ed è disponibile in diversi materiali. Le linee sottili creano un'estetica minimalista e rigorosa, rendendo Line il tavolo perfetto per spazi all'area aperta.

FRAME / TELAIO

Steel / Acciaio



20



03



7016F

TABLE TOP / PIANO TAVOLO

Polipropilene / Polypropylene



S020



S007



S514

HPL (Black core edge/Bordo anima nera)



HPL03



HPL02



HPL04



HPL05

Fenix



FX01



FX02



FX03



FX05

Steel / Acciaio



20



03



7016F

Next, Line Table

REGIONS OF ITALY
Regioni d'Italia

Fiorellina

GOES TO APULIA

 **REGION CAPITAL**
Capoluogo
Bari

 **COORDINATES**
Coordinate
41°03'46"N
16°22'50"E

 **LOCAL PROVERB**
Proverbio locale

**Ci u sule te
settembre è sanu,
rizza puru li munti.**

If the September sun is healthy, it makes even stones curl.

Se il sole di settembre è sano, fa arricciare anche le pietre.

 **REGION CAPITAL TEMPERATURES**
Temperature del capoluogo

 **SUMMER AVERAGE**
Media estiva
23,6°C

 **WINTER AVERAGE**
Media invernale
9,5°C

 **MM OF RAIN PER YEAR**
mm di pioggia all'anno
565 mm



 **PRICKLY PEAR**
Fico d'india
Opuntia ficus-indica

Fiorellina

PERFORATED SEAT
AND BACK WITH
ARMS

DESIGN
FABRIZIO BATONI

Chair/Sedia: S503 Powder blue
polypropylene / Polipropilene
azzurro polvere

Join Table

DESIGN
INFINITI DESIGNERS

Frame/Telaio: 20 Embossed
white steel / Acciaio bianco
goffrato

Table top/Piano tavolo: FX01
White Fenix / Fenix bianco





Fiorellina

Outdoor finishes / Finiture Outdoor

Fiorellina

Lightweight and practical, this chair is characterised by a considerable manufacturing complexity. In fact, it is based on a technology that allows obtaining, from a single mould, four different versions of the product: with solid or with perforated backrest and, both versions, with or without arms. Fiorellina suits well for contract uses, as well as for outdoor uses and summer settings ones.

Pratica e leggera, è una serie caratterizzata da una notevole complessità di realizzazione. Alla base vi è infatti una tecnologia che permette di ottenere dal medesimo stampo quattro diverse declinazioni di prodotto: con schienale pieno o forato, entrambi con o senza braccioli. Una seduta ideale per un uso contract, outdoor o qualsiasi soluzione estiva.

MONOBLOC / MONOSCOCCA

Polypropylene / Polipropilene



Join Table

Join is a table with a single central leg and a three-star base in painted round tube. It is also available an adjustable leg support in die-cast painted aluminium to match the frame. In the fixed version, a die-cast aluminium top supports the table cross. In the folding version, there is a grey plastic folding joint. The table tops come in different geometric shapes and materials, making it perfect in every situation.

Join è un tavolo con una sola gamba centrale e una base a tre razze in tubo tondo verniciato. È disponibile anche una gamba regolabile in alluminio pressofuso verniciato in tinta con la struttura. Nella versione fissa, un piano in alluminio un piano in alluminio pressofuso sostiene la crociera del tavolo. Nella versione versione pieghevole, c'è invece un giunto pieghevole in plastica grigia a supporto. I piani del tavolo sono disponibili in diverse forme geometriche e materiali diversi, rendendolo perfetto in ogni situazione.

FRAME / TELAIO

Steel / Acciaio

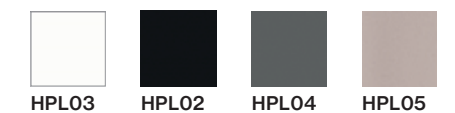

TABLE TOP / PIANO TAVOLO

Polypropylene / Polipropilene



HPL (Black core edge/Bordo anima nera)



Fenix

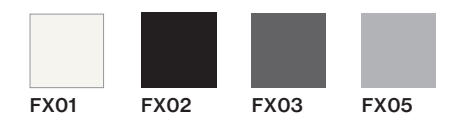

REGIONS OF ITALY
Regioni d'Italia

 **REGION CAPITAL**
Capoluogo
Napoli

 **COORDINATES**
Coordinate
40°49'34"N
14°15'23"E

 **LOCAL PROVERB**
Proverbio locale

Dicette Pulcenella:
mangiammo e bevimmo
ca chi sape si all'auto
munno nce vedimme.

Said Pulcinella: Let's eat and drink,
who knows if we'll see each other
in the next world.

*Disse Pulcinella: mangiamo e
beviamo che chi sa se nell'altro
mondo lo vediamo.*

 **REGION CAPITAL
TEMPERATURES**
Temperature del capoluogo

 **SUMMER AVERAGE**
Media estiva
24,1°C

 **WINTER AVERAGE**
Media invernale
10,1°C

 **MM OF RAIN PER YEAR**
mm di pioggia all'anno
1005 mm

Drop
GOES TO CAMPANIA



 **SAN MARZANO TOMATOES**
Pomodoro San Marzano
Solanum lycopersicum
'San Marzano'

Drop

DESIGN
ORLANDINI RADICE

MONOBLOC / MONOSCOCCA:
S514 Sand Polypropylene /
Polipropilene sabbia

MONOBLOC / MONOSCOCCA:
P557 Light green polypropylene /
Polipropilene verde acqua

Drop Table

ROUND

DESIGN
ORLANDINI RADICE

Frame and top / Telaio e piano:
S514 Sand polypropylene /
Polipropilene sabbia





Drop, Drop Table

Outdoor finishes / Finiture Outdoor

Drop

Awarded with the Good Design Award in 2011, Drop is a chair for contract settings, with a playful design and available in a wide range of colours. It is the ideal synthesis of the dynamic and essential style of the infinity collection. It provides lightness and irony to public spaces, like bars, pubs, and restaurants. This design product is 100% recyclable.

Insignita con un Good Design Award nel 2011, Drop è una seduta per ambienti contract, con un design giocoso e con numerose varianti colore. L'ideale sintesi dello stile dinamico e vitale della collezione infinity. Arreda con ironia e leggerezza spazi pubblici come bar, pub e ristoranti. Prodotto di design riciclabile al 100%.

MONOBLOC / MONOSCOCCA

Polypropylene / Polipropilene



Drop Table

Lightweight, practical and highly stackable, Drop table has been designed for an outdoor use. Made of fiberglass reinforced polypropylene with a co-injection of a second internal material, Drop table is available with both round or square table top.

Leggero, pratico e altamente impilabile, il tavolo Drop è stato concepito per l'uso outdoor. Realizzato in polipropilene caricato in fibra di vetro con iniezione di un secondo materiale interno, il tavolo Drop è disponibile con piano tondo o quadro.

FRAME / TELAIO

Polypropylene / Polipropilene

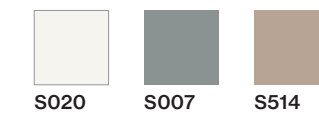

TABLE TOP / PIANO TAVOLO

Polypropylene / Polipropilene



REGIONS OF ITALY
Regioni d'Italia

 **REGION CAPITAL**
Capoluogo
Torino

 **COORDINATES**
Coordinate
45°04'N
7°42'E

 **LOCAL PROVERB**
Proverbio locale

Al ris al nassa int l' aqua e 'l mora int al vin.

Rice is born in water and dies in wine.

Il riso, nasce nell'acqua e muore nel vino.

 **REGION CAPITAL TEMPERATURES**
Temperature del capoluogo

 **SUMMER AVERAGE**
Media estiva
21,2°C

 **WINTER AVERAGE**
Media invernale
4,9°C

 **MM OF RAIN PER YEAR**
mm di pioggia all'anno
980 mm

Flink
GOES TO PIEDMONT

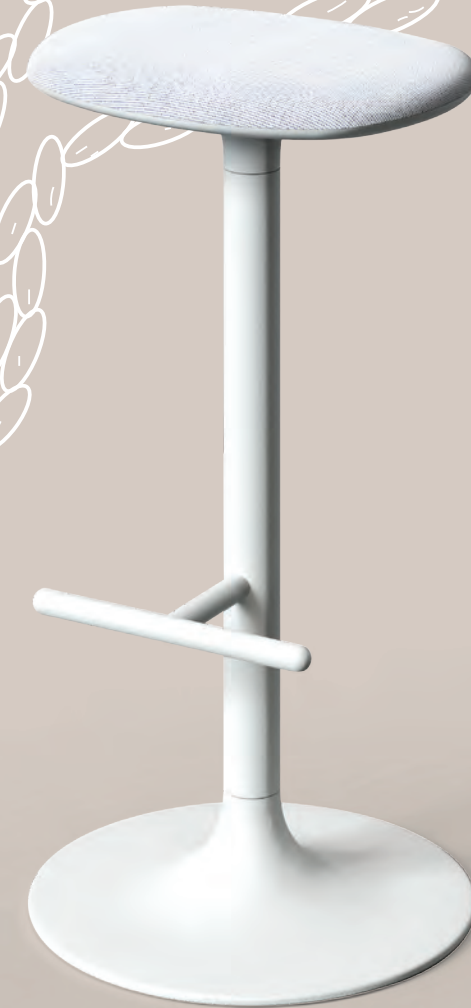

 **RICE**
Riso
Oryza sativa

Flink

DESIGN
THOMAS PEDERSEN

Frame/Telaio: 7016F-E Lead
grey steel / Acciaio grigio piombo
Upholstery/Tappezzeria: Miami
PM11-3006, PM11-5010





Flink

Outdoor finishes / Finiture Outdoor

Flink

A soft and futuristic stool, inspired by the stones found at the beach, which over time have been slowly polished and transformed into pebbles with rounded "friendly" shapes. For this reason, the stool is called Flink, a word that in Danish means "Friendly". Flink stool consists of a structure with a round steel base, an aluminum support, and a seat upholstered with a wide choice of fabrics. In the bar stool and kitchen stool versions, Flink is equipped with a footrest. It is the perfect stool for workplaces, canteens, bars, shops and educational environments. It is available, also, in the new low version, with a height of 45cm, which is ideal for bars and cafes.

Uno sgabello soffice e futurista, ispirato ai sassi trovati di una spiaggia, che nel tempo sono stati lentamente levigati e trasformati in ciottoli dalle forme arrotondate, "amichevoli". Per questo motivo lo sgabello si chiama Flink, una parola che in danese significa "amichevole". Lo sgabello Flink si compone di una struttura con base tonda in acciaio, supporto in alluminio, e un sedile imbottito con molteplici tessuti da esterno. Nelle versioni sgabello bar e sgabello cucina Flink è dotato di un poggia piedi. Perfetto per l'uso in luoghi di lavoro, mense, bar, negozi e ambienti educativi. Disponibile anche nella versione Low, con altezza 45cm, ideale per bar e caffetterie.

FRAME / TELAIO

Steel / Acciaio



UPHOLSTERY / TAPPEZZERIA

B-CHEW TRIO ABITEX
MIAMI PINTAIL

REGIONS OF ITALY
Regioni d'Italia

 **REGION CAPITAL**
Capoluogo
Catanzaro

 **COORDINATES**
Coordinate
38°53'30.48"N
16°35'58.2"E

 **LOCAL PROVERB**
Proverbio locale

**Acqua, cunsigghi
e sali, a cu na
ndumanda, non ci
dari.**

Don't give water, advice
and salt to those who
don't ask for it.

*Acqua consigli e sale, a chi
non te li chiede non li dare.*

 **REGION CAPITAL
TEMPERATURES**
Temperature del capoluogo

 **SUMMER AVERAGE**
Media estiva
23,8°C

 **WINTER AVERAGE**
Media invernale
9,5°C

 **MM OF RAIN PER YEAR**
mm di pioggia all'anno
545 mm

Round&Round

GOES TO CALABRIA

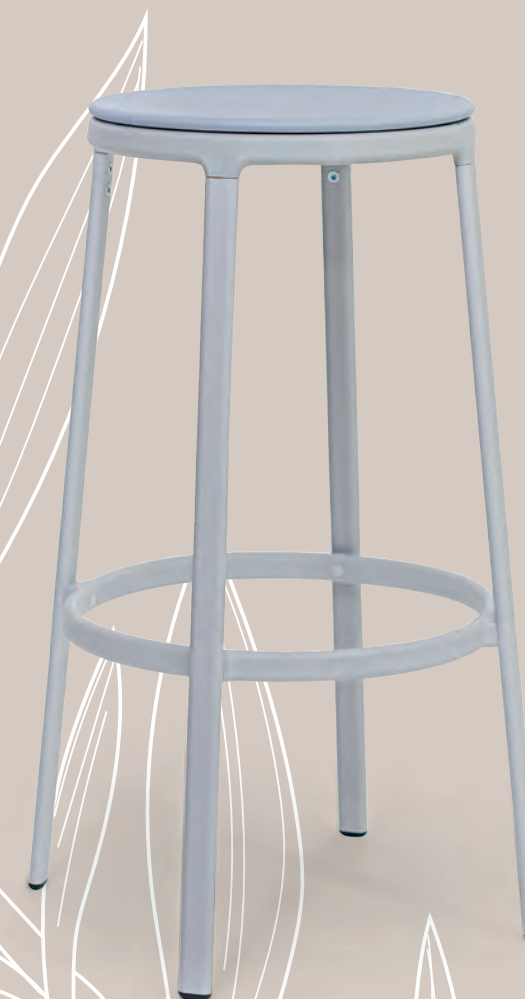

 **OLIVE TREE**
Ulivo
Olea europaea

Round &Round

DESIGN
OLEG PUGACHEV

Frame/Telaio: 9004F-E Black fine textured steel / Acciaio Nero fine texture

Seat/Seduta: IS001 Black post consumer industrial plastic / Polipropilene post consumo industriale nero





Round&Round

Outdoor finishes / Finiture Outdoor

Round&Round

At a first glance, Round&Round appears to be a classic stool, composed of a delicate structure with four legs in painted steel. But the simplicity of the shapes hides a peculiarity: the seat in recycled plastic, which can be upholstered for a greater comfort. Therefore, Round&Round is an essential and delicate piece of furniture, suitable for any context.

Round&Round all'apparenza sembra un classico sgabello, con una delicata struttura quattro gambe in acciaio verniciato. Ma la semplicità delle forme nasconde una particolarità: la seduta in plastica riciclata, che può essere tappezzata per un maggiore comfort. Round&Round è un in un complemento d'arredo essenziale e delicato, adatto a ogni contesto.

FRAME/TELAIO

Steel / Acciaio



PLASTIC SEAT / SEDUTA DI PLASTICA

Post Consumer Industrial Plastic / Polipropilene Post Consumo Industriale



Polypropylene / Polipropilene

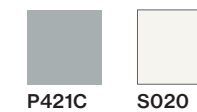

UPHOLSTERY / TAPPEZZERIA

B-CHEW TRIO ABITEX
MIAMI PINTAIL

REGIONS OF ITALY
Regioni d'Italia

 **REGION CAPITAL**
Capoluogo
Genova

 **COORDINATES**
Coordinate
44°24'25.9"N
8°56'02.4"E

 **LOCAL PROVERB**
Proverbio locale

**In bocca serrâ, non
gh'intra mosche.**

Closed mouth catches no
flies.

*Bocca chiusa non piglia
mosche.*

 **REGION CAPITAL
TEMPERATURES**
Temperature del capoluogo

 **SUMMER AVERAGE**
Media estiva
23,3°C

 **WINTER AVERAGE**
Media invernale
10,2°C

 **MM OF RAIN PER YEAR**
mm di pioggia all'anno
77 mm

Klejn
GOES TO LIGURIA



 **GORSE**
Ginestra
Genistea



Klejn

DESIGN
THOMAS PEDERSEN

Frame/Telaio: 30-E Matt black steel / Acciaio nero opaco
Seat / Seduta: S503 Powder blue polypropylene / Poliprilene azzurro polvere

Faro

DESIGN
LUCA PAPINI

Frame and top/Telaio e piano: 7016F Lead grey fine texture steel / Acciaio grigio piombo



Klejn, Faro

Outdoor finishes / Finiture Outdoor

Klejn

Klejn has been created with lightness and simplicity: a minimal design stool, inspired by structures such as cranes and ships of the seaport surrounding Aarhus. It is a slim and light stool in rod steel, and it is equipped with a polypropylene seat available in three heights. Its structure can be painted, which makes Klejn suiting well for outdoors environments.

Klejn è stato creato con leggerezza e semplicità; è uno sgabello minimale, ispirato alle gru del porto di Aarhus. Dalla forma leggera e sottile, in tondino d'acciaio, è dotato di una seduta in polipropilene ed è disponibile in tre altezze. La struttura può essere verniciata, il che rende Klejn adatto per come sgabello da esterno.

FRAME / TELAIO

Steel / Acciaio



SEAT / SEDUTA

Polypropylene / Polipropilene

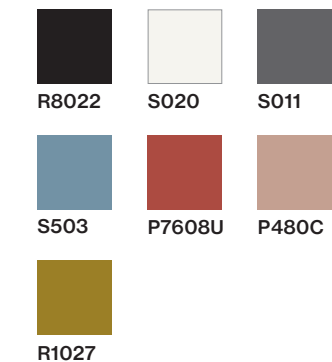

Faro

Faro is a coffee table made of steel, designed for contract environments and perfect also for an outdoor use.

Tavolo di acciaio progettato per ambienti contract e perfetto anche per l'outdoor.

FRAME AND TOP / TELAIO E PIANO

Steel / Acciaio



REGIONS OF ITALY
Regioni d'Italia

Pure Loop Mini

GOES TO TRENTO-SOUTH TYROL

 REGION CAPITAL
Capoluogo
Trento

 COORDINATES
Coordinate
46°04'N
11°07'E

 LOCAL PROVERB
Proverbio locale

Chi che vol el foc
deve 'ngiotir anca
'l fum.

Whoever wants to warm
himself by the fire must
also endure the smoke.

*Chi vuole riscaldarsi al
fuoco deve sopportare
anche il fumo.*

 REGION CAPITAL
TEMPERATURES
Temperature del capoluogo

 SUMMER AVERAGE
Media estiva
16,7°C

 WINTER AVERAGE
Media invernale
0,5°C

 MM OF RAIN PER YEAR
mm di pioggia all'anno
1002 mm

 PORCINI MUSHROOMS
Funghi porcini
Boletus edulis



Pure Loop Mini

DESIGN
CLAUS BREINHOLT

Frame/Telaio: 31-E Black steel /
Acciaio nero

Shell/Scocca: S513 Military
green polypropylene /
Polipropilene verde militare





Pure Loop Mini Dandy

Outdoor finishes / Finiture Outdoor

Pure Loop Mini

The "Pure Loop" shell becomes "Mini", assembled on different types of stool frames. All versions feature a polypropylene shell, which, combined with a painted steel frame, is ideal for outdoor areas. Pure Loop Mini is an intelligent solution for combining sophistication and ergonomics.

La scocca "Pure Loop" diventa "Mini", assemblata su diversi tipi di telai per sgabelli. Tutte le versioni presentano la scocca in polipropilene, che combinata a un telaio verniciato è ideale per le aree all'aria aperta. Pure Loop Mini è una soluzione intelligente per abbinare raffinatezza ed ergonomia.

FRAME / TELAIO

Steel / Acciaio



30-E



31-E

SHELL / SCOCCA

Polypropylene / Polipropilene



S020



R8022



S513



P7608U



S503



S514



P421C

REGIONS OF ITALY
Regioni d'Italia

 **REGION CAPITAL**
Capoluogo
Bologna

 **COORDINATES**
Coordinate
44°30'38"N
10°57'25"E

 **LOCAL PROVERB**
Proverbio locale

**Quand che al nuval
al va a Bulogna
e piòv c'un
s'vargogna.**

When the clouds move
towards Bologna it is
a sign of heavy rain.

*Quando le nuvole vanno
verso Bologna segno di
pioggia abbondante.*

 **REGION CAPITAL
TEMPERATURES**
Temperature del capoluogo

 **SUMMER AVERAGE**
Media estiva
23,4°C

 **WINTER AVERAGE**
Media invernale
5,7°C

 **MM OF RAIN PER YEAR**
mm di pioggia all'anno
670 mm

Sys
GOES TO EMILIA ROMAGNA



 **WILD CHERRY**
Ciliegio Selvatico
Prunus avium

Sys

DESIGN
MC.DSG

Frame/struttura: 9004F Black steel / Acciaio nero

Upholstery / Tappezzeria: B-chew trio 807, 603, 803

Tables/Tavolini: HPL02 Black / Nero





Sys

Outdoor finishes / Finiture Outdoor

Sys

Sys was born as a sofa full of configurations, which gives the possibility of creating modular systems, that fit well in contexts such as waiting rooms, work spaces, museums, restaurants, schools, shops and meeting and sharing areas. Thanks to an extremely quick and intuitive fastening system, it is possible to disassemble, move and reconfigure your sofa, according to the needs of that moment. Sys is made up of a painted steel frame, which creates an housing for the modules to be inserted.

Sys nasce come un divano ricco di configurazioni, che dà la possibilità di creare sistemi modulari che ben si inseriscono in contesti quali sale d'attesa, spazi di lavoro, musei, ristoranti, scuole, negozi e aree di incontro e condivisione. Grazie a un sistema di aggancio di moduli estremamente veloce e intuitivo, è possibile smontare, spostare e riconfigurare il proprio divano in base alle esigenze del momento. Sys è formato da un telaio in tubo di acciaio verniciato, che crea un alloggio per i moduli da inserire.

FRAME / TELAIO

Steel / Acciaio



20



9004F

TABLE TOP / PIANO TAVOLO

HPL (Black core edge/Bordo anima nera)



HPL03



HPL02



HPL04



HPL05

Fenix



FX01



FX02

UPHOLSTERY / TAPPEZZERIA

B-CHEW TRIO ABITEX

REGIONS OF ITALY
Regioni d'Italia

 **REGION CAPITAL**
Capoluogo
Aosta

 **COORDINATES**
Coordinate
45°44'14"N
7°19'14"E

 **LOCAL PROVERB**
Proverbio locale

**Se fait solei lo dzor de
Saint Ors, hiver dure inc
quarenta dzor.**

If the weather is fine on St Orso's Day (early February), winter lasts another forty days.

Se il tempo è bello il giorno di S.Orso (inizio febbraio), l'inverno dura ancora quaranta giorni.

 **REGION CAPITAL TEMPERATURES**
Temperature del capoluogo

 **SUMMER AVERAGE**
Media estiva
20°C

 **WINTER AVERAGE**
Media invernale
3,7°C

 **MM OF RAIN PER YEAR**
mm di pioggia all'anno
555 mm

Demoiselle

GOES TO AOSTA VALLEY



 **JUNIPER**
Ginepro
Juniperus

Demoiselle

DESIGN
QUAGLIO SIMONELLI

Frame/Telaio: 30 Matt white steel / Acciaio bianco opaco

Upholstery/Tappezzeria:
B-chew Trio di Abitex cod. 807

Belt/Cintura: PC Light brown leather / Cuoio Marrone chiaro





Outdoor finishes / Finiture Outdoor

Demoiselle

Quaglio Simonelli designers present an elegant armchair characterised by soft lines and a structure covered with double ton-on-ton upholstery, tied with a sophisticated leather belt. The comfort is ensured by a deep seat and a large cushion. The structure is in expanded polyurethane and the seat and the cushion are in cold-foamed polyurethane, upholstered in leather, eco-leather or fabric. Demoiselle stands on four matt painted steel legs. The choice of outdoor upholstery makes this sofa a product suitable for any context.

I designer Quaglio Simonelli propongono un elegantissimo divanetto dalle geometrie morbide, con struttura rivestita con doppia tappezzeria tono su tono legate da un cinturino di cuoio elegantissimo. Comfort assicurato grazie ad una seduta profonda e da ampio cuscino. Poltroncina con struttura in poliuretano espanso, seduta e cuscino in poliuretano schiumato a freddo. La scelta della tappezzeria da esterno rendono questo divanetto un prodotto adatto ad ogni contesto.

FRAME / TELAIO

Steel / Acciaio



30

31

BELT / CINTURA

Leather / Pelle



PN

PTM

PC

UPHOLSTERY / TAPPEZZERIA

B-CHEW TRIO ABITEX

Demoiselle

REGIONS OF ITALY
Regioni d'Italia

 **REGION CAPITAL**
Capoluogo
Trieste

 **COORDINATES**
Coordinate
45°38'10"N
13°48'15"E

 **LOCAL PROVERB**
Proverbio locale

Vin e amìs, un paradìs.

Wine and friends, they are a paradise.

Vino e amici, sono un paradiso.

 **REGION CAPITAL TEMPERATURES**
Temperature del capoluogo

 **SUMMER AVERAGE**
Media estiva
23,3°C

 **WINTER AVERAGE**
Media invernale
7,8°C

 **MM OF RAIN PER YEAR**
mm di pioggia all'anno
1000 mm

Record Living

GOES TO FRIULI VENICE JULIA



 **MALUS**
Melo selvatico
Malus sylvestris

Record Bench

DESIGN
MC.DSG

Frame/Telaio: 03 Black Steel /
Acciaio Nero
Bench top/piano panca: RFS01
Recycled fiberglass / Fibra
rigenerata

Record Living

DESIGN
MC.DSG

Frame/Telaio: 03 Black steel /
Acciaio Nero
Table top/Piano tavolo: RFS01
Recycled fiberglass / Fibra
rigenerata





Record Living

Outdoor finishes / Finiture Outdoor

Record Bench

Record Bench, like the rest of the Record family, was born from the idea that are the crossed lines themselves that support the top of the bench. The bench is made up of a simple structure in painted steel, which can be realised in different materials, both for an outdoor and an indoor use. The simplicity and harmony of the shapes that characterise it make Record Bench an extremely versatile piece of furniture.

Record Bench, come il resto dell'omonima famiglia, nasce dall'idea che siano delle linee incrociate a sostenere il piano. La panca si compone infatti di una semplice struttura in acciaio verniciato, e da un piano che può essere realizzato in diverse finiture, sia da esterno che da interno. La semplicità e l'armonia delle forme che lo caratterizzano rendono Record Bench un arredo estremamente versatile.

FRAME / TELAIO

Steel / Acciaio

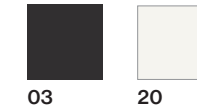

BENCH TOP / PIANO PANCA

Fenix



Recycled Fibreglass



RFS01

Record Living

Record is an innovative design table, which combines style and versatility through the combination of simple lines. Legs and footrest intersect without screws, giving an impressing and appealing touch to the details. The table top is available in a wide range of dimensions and finishes, that is why it fits well both in domestic and in contract environments. Record Living fits into every Nordic style and personality environment.

Record è un innovativo tavolo di design, che combina stile e versatilità attraverso l'unione di linee semplici. Gambe e poggiatesta si intersecano senza la necessità di viti, conferendogli un tocco suggestivo ed elegante. I piani del tavolo presentano diverse soluzioni in termini di dimensioni e finiture. Questo lo rende un tavolo adatto sia per ambienti domestici che per ambienti contract. Il tavolo Record Living veste ogni ambiente di personalità e stile nordico.

LEGS / GAMBE

Steel / Acciaio

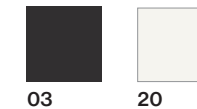

TABLE TOP / PIANO TAVOLO

Fenix



Recycled Fibreglass



RFS01



CAPITAL
Capitale
 Città di San Marino



COORDINATES
Coordinate
 43° 56' 0"N
 12° 28' 0" E



LOCAL PROVERB
Proverbio locale

**La fni' 'nche'
 agl'j'anusi ma
 Baracoch!**

Baracoch's nuts are finished! (everything can happen)

Sono terminate anche le noci a Baracoch!



REGION CAPITAL TEMPERATURES
Temperature del capoluogo



SUMMER AVERAGE
Media estiva
 19°C



WINTER AVERAGE
Media invernale
 7,5°C



MM OF RAIN PER YEAR
mm di pioggia all'anno
 770 mm

SAN MARINO REPUBLIC
 Repubblica di San Marino

Jit Table

GOES TO SAN MARINO



SERVICE TREE
Ciavardello
 Sorbus torminalis

Jit Table

3 LEGS WITH
A PYRAMID BASE

DESIGN
GREGORIO FACCO

Frame/Telaio: 03 Black frame /
Acciaio nero

Table top/Piano tavolo: HPL02
Black / Nero

Jit Table

3 LEGS ON THE FLOOR

DESIGN
GREGORIO FACCO

Frame/Telaio: 03 Black frame /
Acciaio nero

Table top/Piano tavolo: HPL02
Black / Nero

Tondina Slim

DESIGN
FAVARETTO&PARTNERS

Frame / Telaio: 31-E Black steel /
Acciaio nero

**Seat and Backrest/Seduta e
Schienale:** IP7608U Marsala
post consumer polypropylene/
Polipropilene post consumo
industriale marsala

Tondina Pop

DESIGN
FAVARETTO&PARTNERS

Frame / Telaio: 31-E Black steel /
Acciaio nero

**Seat and Backrest/Seduta e
Schienale:** P421C Almond grey
p-olypropylene / Polipropilene
grigio mandorla





Tondina Slim, Jit Table

Outdoor finishes / Finiture Outdoor

Tondina Slim

Tradition and innovation come together in Tondina Slim, a chair with or without armrests designed by Favaretto&Partners. The latest addition to the Tondina family is distinguished by an unmistakable openwork texture, which recalls the traditional weave of the 1950s reinterpreted in a more contemporary version. A painted rod frame and a wide range of colours for the micro-perforated seat and backrest make Tondina Slim an ideal chair for furnishing outdoor spaces with harmony.

Tradizione e innovazione confluiscono in Tondina Slim, una sedia con o senza braccioli disegnata da Favaretto&Partners. L'ultima nata della famiglia Tondina è contraddistinta da una inconfondibile texture traforata, che rimanda alla trama tradizionale degli anni '50 reinterpretata in una versione più contemporanea. Grazie ad un telaio in tondino verniciato ed un'ampia palette colori del sedile e dello schienale microforati, Tondina Slim diventa una seduta ideale per arredare con armonia gli ambienti esterni.

FRAME / TELAIO

Steel / Acciaio

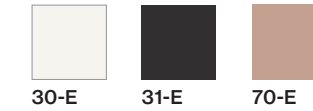

SEAT AND BACKREST / SEDUTA E SCHIENALE

Post Consumer Industrial Plastic / Polipropilene Post Consumo Industriale



Polypropylene / Polipropilene



Jit Table

The Jit table collection was created with simple yet functional shapes in mind. A generously sized steel tube frame is interpenetrated with an additional curved section, which seems to rest gently on itself. Jit is available with two different types of bases: with three legs on the ground, with fixed or adjustable feet in three heights, or with a pyramid base, in bar or kitchen height and with an optional folding mechanism; in this version, horizontal "nesting" stacking is possible.

La collezione di tavoli Jit è stata creata avendo in mente forme semplici, ma funzionali. Un telaio in tubo di acciaio, dalle dimensioni generose, si compenetra con un'ulteriore sezione circolare incurvata, che sembra appoggiarsi delicatamente su stessa. Jit è disponibile con due diversi tipi di base: a tre razze a terra, con piedini fissi o regolabili in tre altezze, o a piramide, in altezza bar o cucina e con meccanismo reclinabile del top a richiesta; in questa versione, infatti, è possibile l'impilaggio orizzontale.

FRAME / TELAIO

Steel / Acciaio



TABLE TOP / PIANO TAVOLO

HPL (Black core edge/Bordo anima nera)



Fenix



Steel / Acciaio

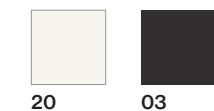

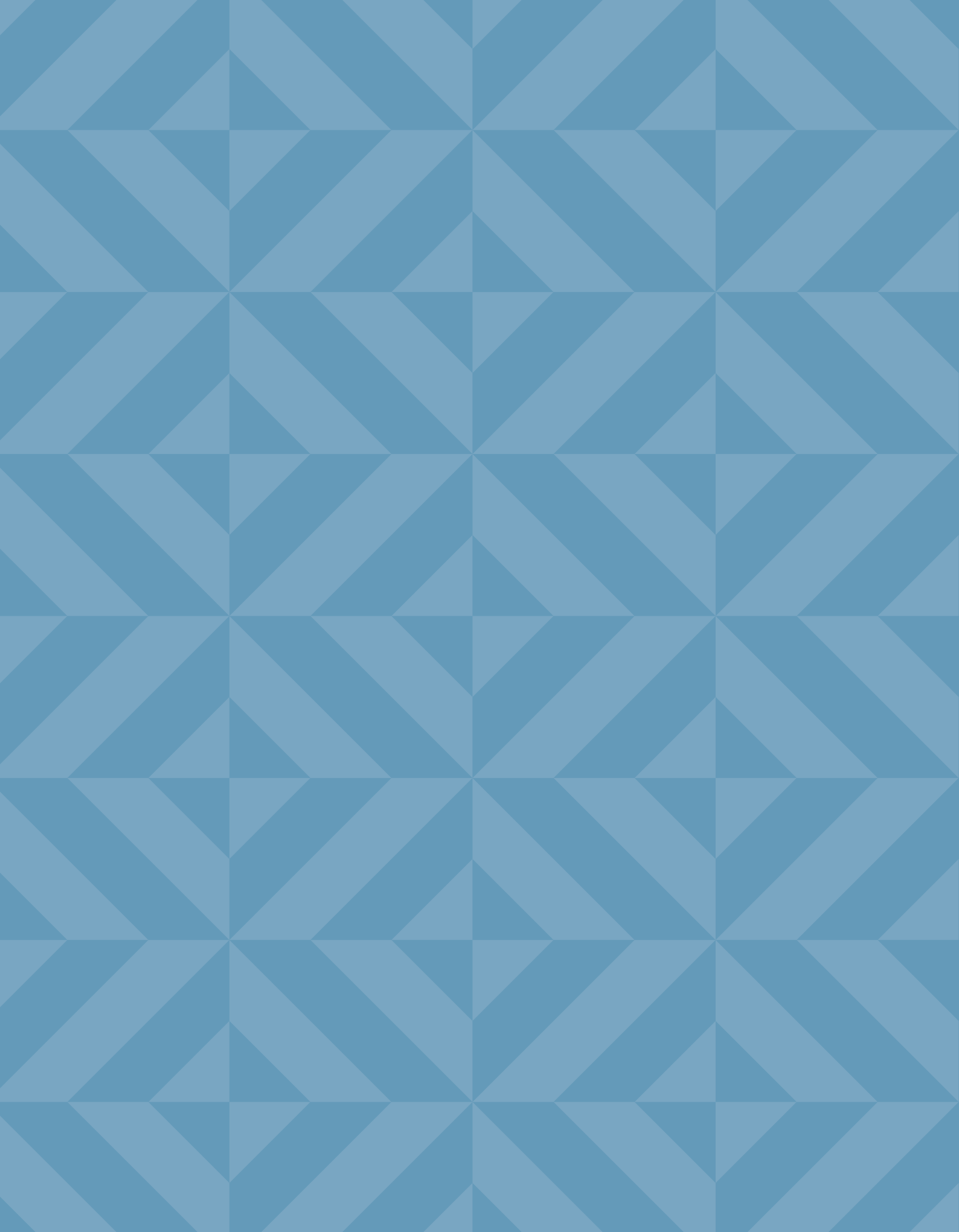

Technical drawings

DISEGNI TECNICI



CHAIRS / SEDIE

Canova
CLAUS BREINHOLT

CANOVA
5005-4LGT

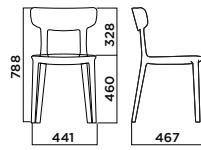

Demoiselle
QUAGLIO SIMONELLI

DEMOISELLE
chair
5008-AC1T

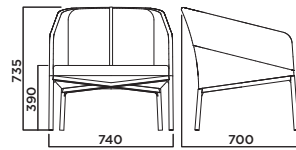

DEMOISELLE
sofa
5008-AC2T

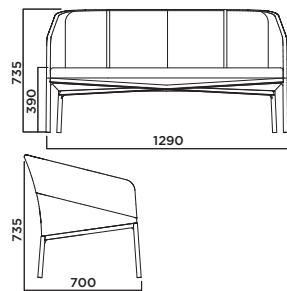

Drop
RADICE ORLANDINI

DROP
5009-4LGP

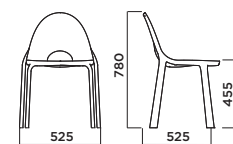

Feluca Pop
BROGLIATOTRAVERSO

FELUCA POP
5091-4LGP

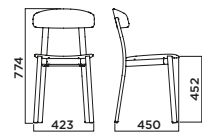

FELUCA POP
bar stool
5091-BSTP

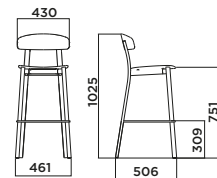

FELUCA POP
kitchen stool
5091-KSTP

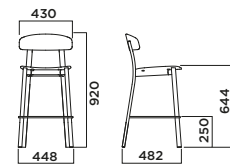

Fiorellina
FABRIZIO BATONI

FIGRELLINA
perforated seat and back
5012-PSSP

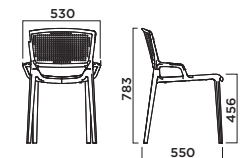

FIGRELLINA
perforated seat and back with arms
5012-PWAP

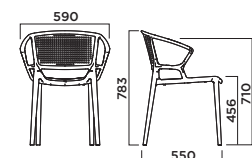

FIGRELLINA
full seat and back
5012-FSSP

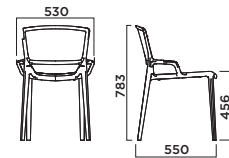

FIGRELLINA
full seat and back with arms
5012-FWAP

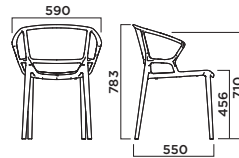

Flink
THOMAS PEDERSEN

FLINK
bar stool
5013-BSTT

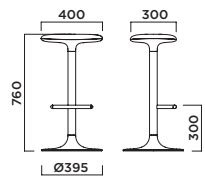

FLINK
kitchen stool
5013-KSTT

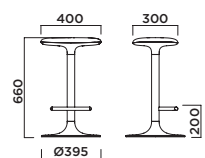

FLINK
low stool
5013-LSTT

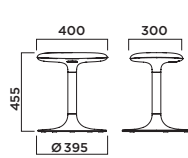

CHAIRS / SEDIE

Klejn
THOMAS PEDERSEN

KLEJN
bar stool
5016-BSTP

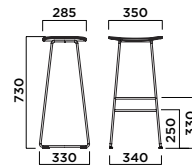

KLEJN
kitchen stool
5016-KSTP

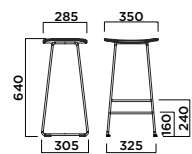

KLEJN
low stool
5016-LSTP

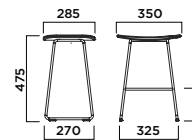

Loop Mono
CLAUS BREINHOLT

LOOP MONO
4 legs
5088-4LGP

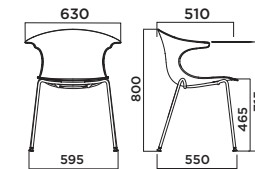

LOOP MONO
4 legs Non - stackable
5088-4LNP

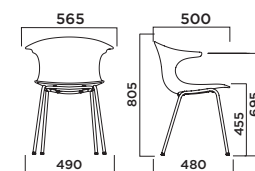

LOOP MONO
sled
5088-SLDP

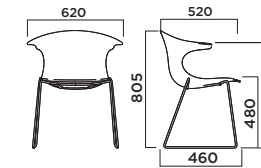

Next
ANDREAS OSTWALD

NEXT 4 LEGS OUTDOOR
5023-4ODP

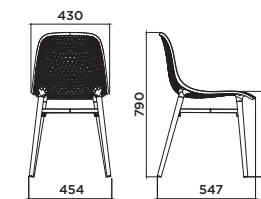

Pure Loop Mini
CLAUS BREINHOLT

PURE LOOP MINI
4 legs kitchen stool
5032-4KSP

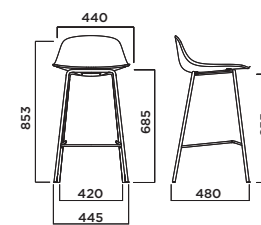

PURE LOOP MINI
4 legs bar stool
5032-4BSP

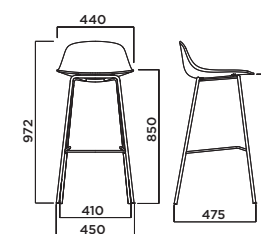

PURE LOOP MINI
rod kitchen stool
5032-SKSP

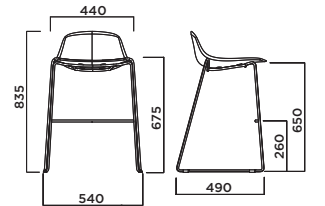

PURE LOOP MINI
rod bar stool
5032-SBSP

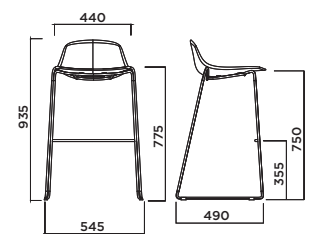

PURE LOOP MINI
dandy kitchen stool
5032-DKSP

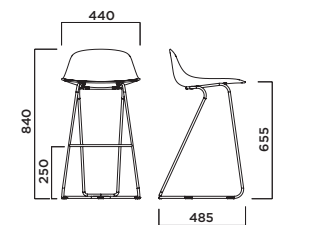

PURE LOOP MINI
dandy bar stool
5032-DBSP

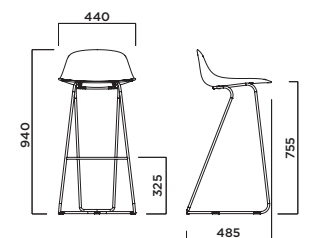

CHAIRS / SEDIE

Pure Loop Mono
CLAUS BREINHOLT

PURE LOOP MONO
4 legs
5034-4LGP

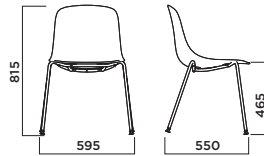

PURE LOOP MONO
4 legs Non stackable
5034-4LNP

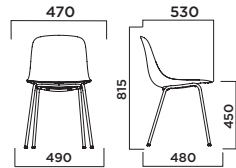

PURE LOOP MONO
4 legs with arms
5034-4LCP

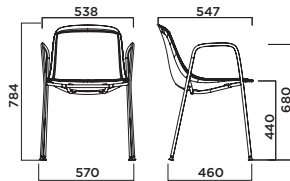

PURE LOOP MONO
sled
5034-SLDP

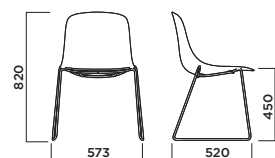

Record Bench
MC.DSG

RECORD BENCH
5035-4BEW

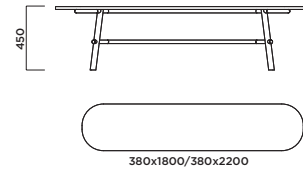

Round&Round
OLEG PUGACHEV

ROUND&ROUND
kitchen stool plastic seat - Fixed
5093-KSTP

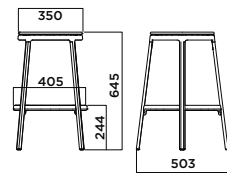

ROUND&ROUND
bar stool plastic seat - Fixed
5093-BSTP

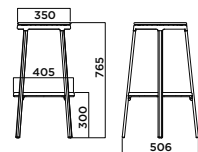

ROUND&ROUND
kitchen stool upholstered seat - Fixed
5093-KSTT

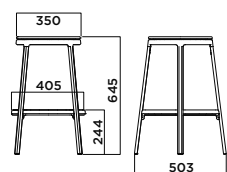

ROUND&ROUND
bar stool upholstered seat - Fixed
5093-BSTT

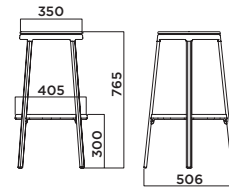

Ruelle

PHILIPPE TABET

RUELLE
plastic back
5037-4LGP

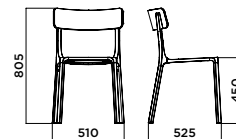

RUELLE
wooden back
5037-4LGW

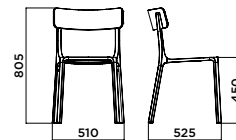

RUELLE
outdoor
5037-4ODP

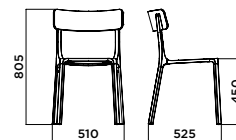

RUELLE
veranda
5037-4VEW

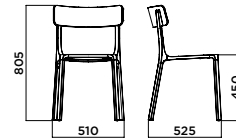

CHAIRS / SEDIE

RUELLE
plastic back upholstered seat panel
5037-4LGS

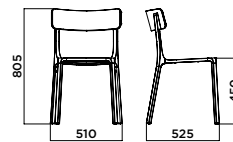

Sys

MC.DSG

SYS
two-seater structure module
CT5095SO2

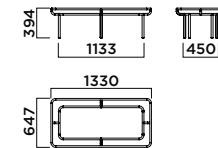

SYS
three-seater structure module
CT5095SO3

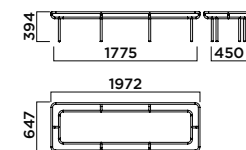

SYS
four-seater structure module
CT5095SO4

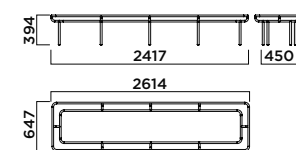

SYS
cushion module
CS10-5095

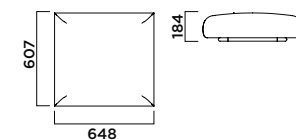

SYS
cushion module with backrest
CS02-5095

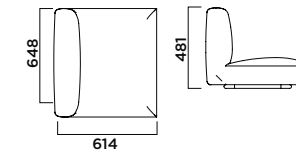

SYS
table module
CS11-5095

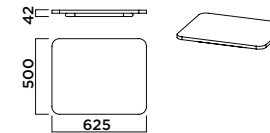

SYS
junction table
5095-TS1W

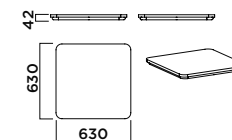

SYS
corner table
5095-TS2W

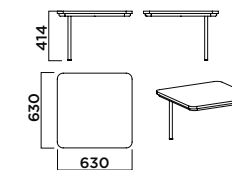

SYS
side table
5095-TS3W

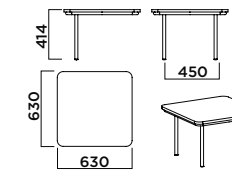

SYS
free standing table
5095-TS4W

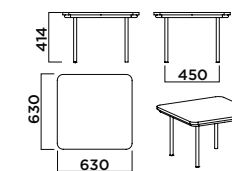

SYS
high coffee table
CA5095SO3

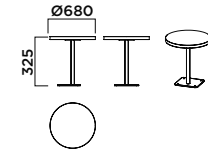

Tondina Pop

FAVARETTO&PARTNERS

TONDINA POP
4 legs
5043-4LGP

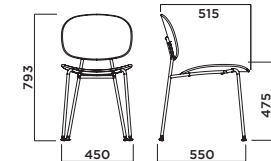

TONDINA POP
4 legs with arms
5043-4LCP

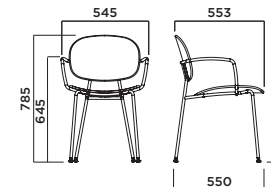

TONDINA POP
bar stool
5043-BSTP

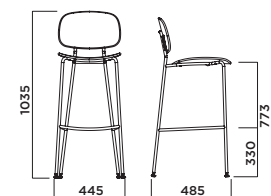

TONDINA POP
kitchen stool
5043-KSTP

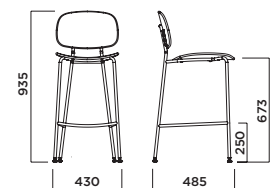

CHAIRS / SEDIE

Tondina Slim
FAVARETTO&PARTNERS

TONDINA SLIM
4 legs
5098-4LGP

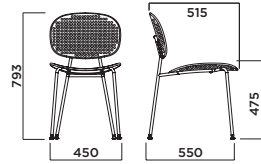

TONDINA SLIM
4 legs with arms
5098-4LCP

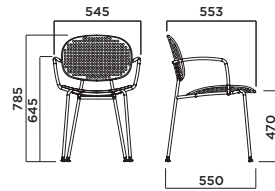

Úti e Úti Rope
MC.DSG

ÚTI
steel back with arms
5044-4CSI

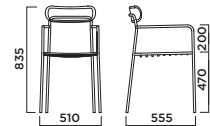

ÚTI
plastic back with arms
5044-4LCT

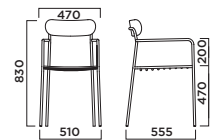

ÚTI
steel back
5044-4SWI

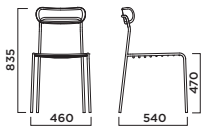

ÚTI
plastic back
5044-4LGT

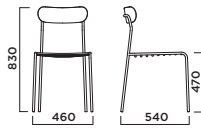

ÚTI
wooden back
5044-4LWW

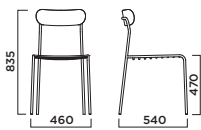

ÚTI
wooden back with arms
5044-4WCW

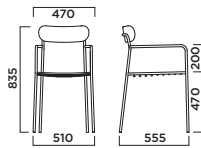

ÚTI ROPE
4 legs
5101-04LR

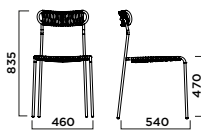

ÚTI ROPE
4 legs with arms
5101-04AR

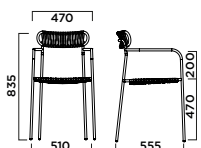

TABLES / TAVOLI

Drop Table
ORLANDINI&RADICE

DROP TABLE
h710 round
5061-FTR1

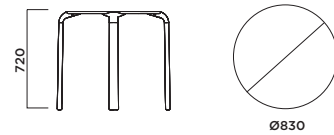

DROP TABLE
h710 square
5061-FTS1

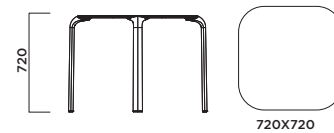

Faro
LUCA PAPINI

FARO
5064-FT21

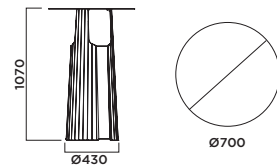

Feluca Table
BROGLIATOTRAVERSO

FELUCA TABLE
4 stars H 710
5094-4F11

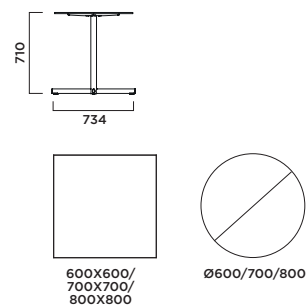

FELUCA TABLE
4 stars H 1070
5094-4F21

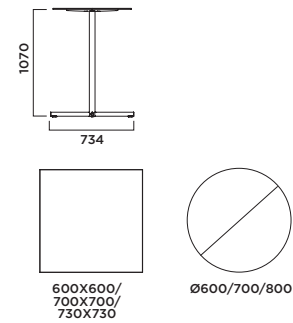

FELUCA TABLE
3 stars H 710
5094-3V11

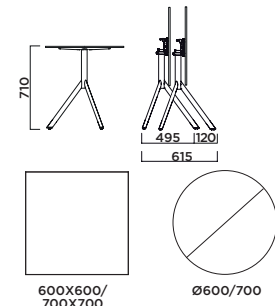

FELUCA TABLE
3 stars H 1070
5094-3V21

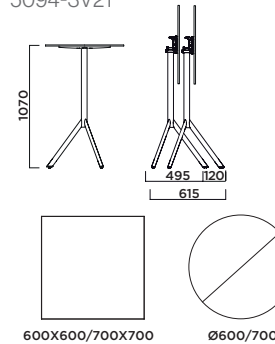

Flink Table
THOMAS PEDERSEN

FLINK TABLE
H 450
5081-FT31

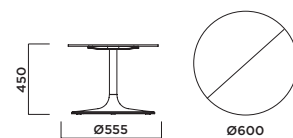

FLINK TABLE
H 710
5081-FT11

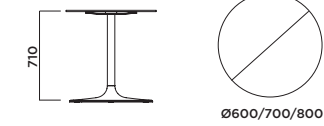

FLINK TABLE
H 1070
5081-FT21

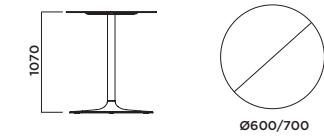

Ipe
ARTER & CITTON

IPE
H 710
5065-FT11

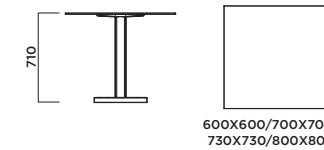

IPE
H 1070
5065-FT21

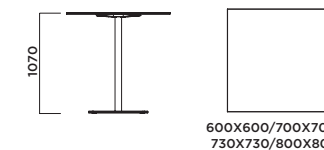

Join Table
INFINITI DESIGNERS

JOIN
round/square fixed H 710
5066-FT11

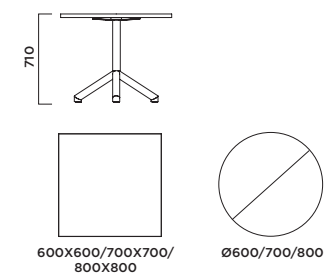

JOIN
round/square folding top H 710
5066-FT12

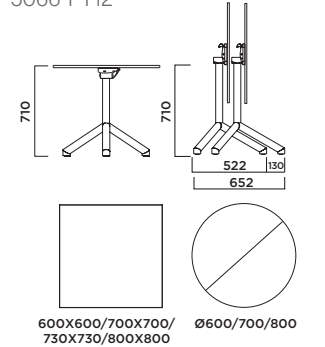

JOIN
round/square fixed H 1070
5066-FT21

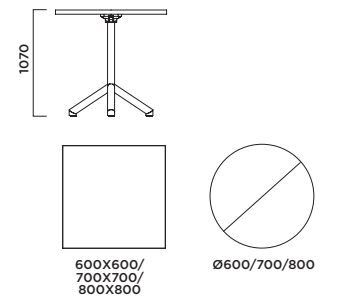

JOIN
round/square folding top H 1070
5066-FT22

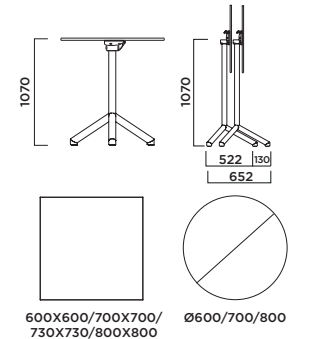

TABLES / TAVOLI

Line

BROGLIATOTRAVERSO

LINE
round/square H 710
5068-FT11

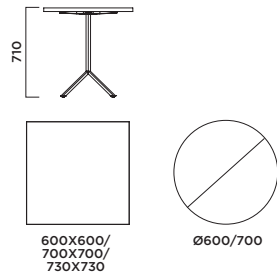

Loop Table

CLAUS BREINHOLT

LOOP TABLE
H 450
5069-FT31

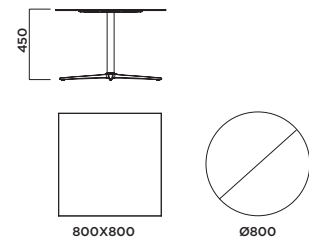

LOOP TABLE
H 710
5069-FT11

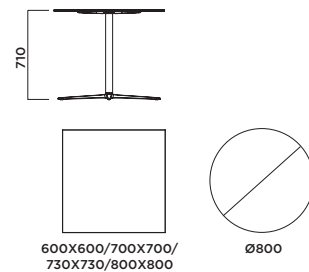

LOOP TABLE
H 1070
5069-FT21

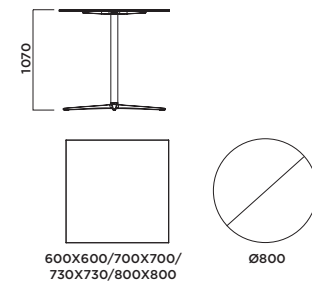

Record Contract

MC.DSG

RECORD CONTRACT
H 450
5076-FT31

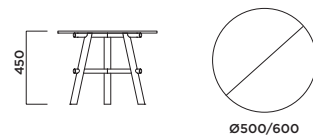

RECORD CONTRACT
H 710
5076-FT11

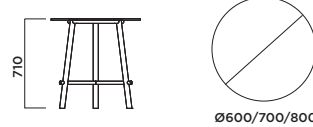

RECORD CONTRACT
H 1070
5076-FT21

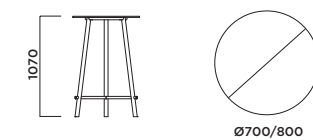

Record Living

MC.DSG

RECORD LIVING
4 legs oval
5077-TO11

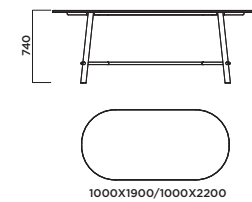

RECORD LIVING
4 legs square
5077-FQ11

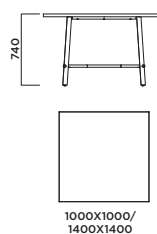

RECORD LIVING
3 legs round
5077-FT11

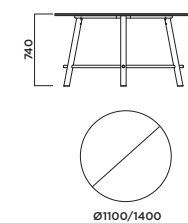

RECORD LIVING
4 legs maxi
5077-FR11

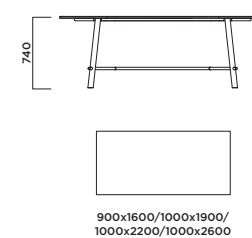

TABLES / TAVOLI

Ruelle Table

PHILIPPE TABET

RUELLE TABLE
H 710
5090-VT11

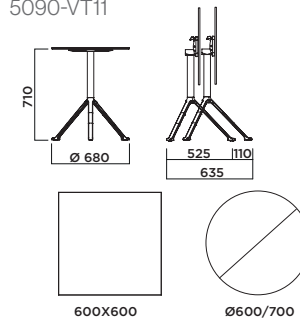

RUELLE TABLE
H 1070
5090-VT21

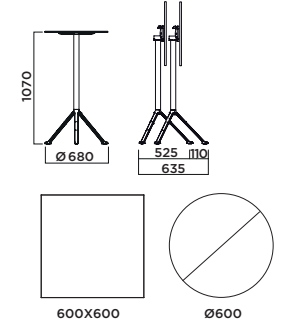

Jit Table

GREGORIO FACCO

JIT TABLE
3 legs on the floor H 710
5104-LF11

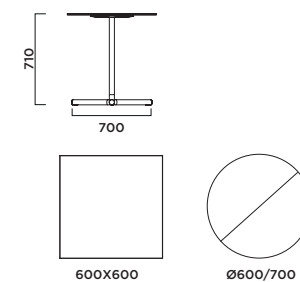

JIT TABLE
3 legs on the floor H 1070
5104-LF12

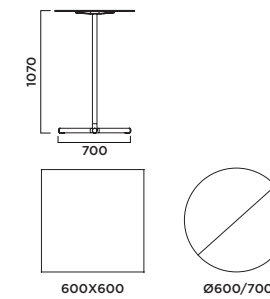

JIT TABLE
3 legs on the floor H 450
5104-LF13

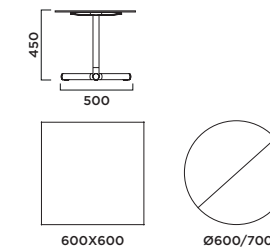

JIT TABLE
3 legs with a pyramid base H 710
5104-LP11

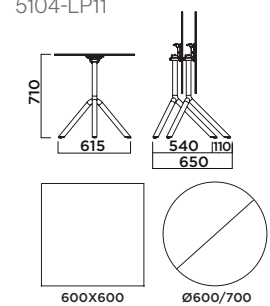

JIT TABLE
3 legs with a pyramid base H 1070
5104-LP12

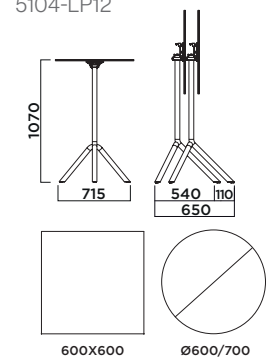

EDGES / BORDI

STEEL
Acciaio
3mm (Edge/bordo)



HPL
HPL
10mm (Edge/bordo)



FENIX
Fenix
10mm (Edge/bordo)



POLYPROPYLENE
Polipropilene
18mm (Edge/bordo)

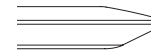

RFS
RFS
20mm (Edge/bordo)



MARBLE
Marmo
20mm (Edge/bordo)



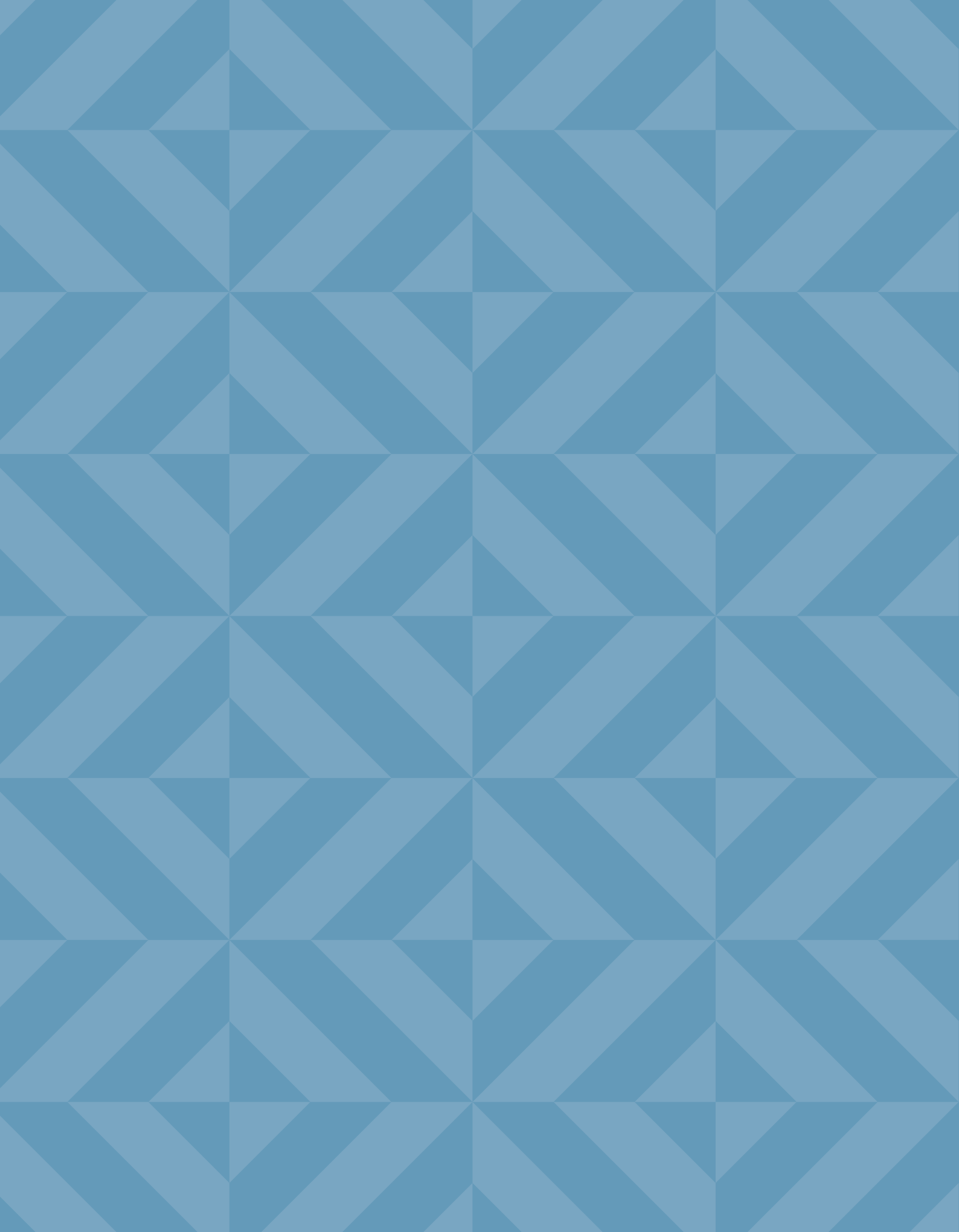

Outdoor Finishes

FINITURE OUTDOOR



PLASTIC MATERIALS

Polypropylene is a thermoplastic polymer characterized by a good breaking load, a good thermal and abrasion resistance. Its formulation allows it to reduce the negative effects of the combined action of external agents such as water, light, etc. Material suitable for outdoor use.



Materiali plastici







Il polipropilene (PP) è un polimero termoplastico caratterizzato da un buon carico di rottura, una buona resistenza termica e all'abrasione. La sua formulazione gli permette di ridurre gli effetti negativi dell'azione combinata di agenti esterni quali acqua, luce, ecc. Materiale adatto all'utilizzo esterno.

Polypropylene / Polipropilene

					
S020 Bianco White	S021 Grigio perla Pearl grey	S007 Grigio cemento Cement grey	S011 Antracite Anthracite	R1012 Senape Mustard	S514 Sabbia Sand
					
R3020 Rosso Red	S022 Tabacco Tobacco	S513 Verde militare Military green	R8022 Nero carbone Coal black	R7015 Grigio ardesia Slate grey	P421C Grigio mandorla Almond grey
					
P480C Cipria Cipria	P557C Verde acqua Light green	P7608U Marsala Marsala	R1027 Curry Curry	R1034 Pesca Peach	S503 Azzurro polvere Powder blue

Post Consumer Industrial Polypropylene / Polipropilene Post Consumo Industriale



					
IS011 Antracite Anthracite	IS022 Tabacco Tobacco	IS513 Verde militare Military green	IR8022 Nero carbone Coal black	IP7608U Marsala Marsala	IS001 Nero Black
					
IR6013 Verde canna Reed green					

Polyamide / Poliammide

		
S101 Bianco White	S117 Grigio siliceo Silica grey	S102 Nero Black

METALS

Steel is a material with good strength and workability. Special cataphoresis and powder or liquid coating treatments, tested to minimize the effect of external agents, make it suitable for outdoor use.

Aluminium is a light material with good mechanical properties. Special cataphoresis and powder or liquid coating treatments make it suitable for outdoor use.

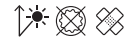

					
20 Bianco gofrato Embossed white	03 Nero gofrato Embossed black	43 Acquamarina fine texture Aquamarine blue fine textured	3009F Rosso ossido fine texture Oxide red fine textured	9004F Nero fine texture Black fine textured	S514-E Goftrato sabbia Embossed sand
					
30-E Bianco opaco Matt white	31-E Nero opaco Matt black	7006F-E Grigio tortora fine texture Dove grey fine textured	7016 F-E Grigio piombo fine texture Lead grey fine textured	7035F-E Grigio luce fine texture Light grey fine textured	1032F-E Giallo ginestra fine texture Broom yellow fine textured
					
1019F-E Beige grigio fine texture Beige grey fine textured	503F-E Azzurro polvere fine texture Powder blue fine textured	70-E Cipria Cipria	79-E Giallo ocre Ochre yellow	78-E Rosso corallo Coral red	6013F-E Verde canna Reed green
					
7006F-E Tortora Dove grey					

Metalli



L'acciaio è un materiale con buone proprietà di resistenza e lavorabilità. Gli appositi trattamenti di cataforesi e verniciatura a polveri o liquido, testati per minimizzare l'effetto degli agenti esterni, lo rendono adatto all'uso esterno.

L'alluminio è un materiale leggero e con buone proprietà meccaniche. Gli appositi trattamenti e la verniciatura a polveri o liquido lo rendono adatto all'uso esterno.

**HPL
Black core edge**

HPL (High Pressure Laminate) is a self-supporting material, with a 10 mm thick black visible edge. It's resistant to abrasion, bumps, scratches and common solvents and to the outdoors. It's antibacterial and, therefore, suitable for contact with food, moreover, it's easy to clean with common household detergents.



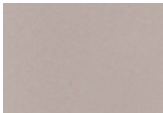



			
HPL03 Bianco White	HPL02 Nero Black	HPL04 Antracite Anthracite	HPL05 Grigio tortora Dove grey

FENIX NTM®

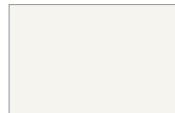
Innovative-nanotech material, ultra matt and soft touch- conceived for interior design. With low light reflection, its surface is highly matt, anti-fingerprints and pleasantly soft touch. The exterior side of FENIX NTM is obtained with nanotechnologies and is characterised by a surface treated with acrylic resins of new generation, hardened and bound through the Electron Beam Curing process. Thanks to these characteristics, Fenix NTM regenerates itself from any surface micro-scratches thanks to its thermo-repairing quality.



			
FX01 Bianco White	FX02 Nero Black	FX03 Antracite Anthracite	FX05 Grigio chiaro Light grey

**HPL
Bordo anima nera**

L'HPL (High Pressure Laminate) è un materiale autoportante, con bordo a vista in colore nero di spessore 10 mm. È resistente all'abrasione, agli urti, ai graffi e ai comuni solventi ed è resistente all'ambiente esterno. È antibatterico e dunque adatto al contatto con gli alimenti, oltre che facile da pulire utilizzando i comuni detersivi domestici.

Fenix NTM®

Materiale innovativo - nanotech, super opaco - creato per l'interior design. Con una bassa riflessione della luce, la sua superficie è estremamente opaca, anti impronte digitali e piacevolmente soft touch. La parte esteriore di FENIX NTM® NTM è ottenuta con l'ausilio di nanotecnologie ed è caratterizzata da una superficie trattata con resine acriliche di nuova generazione, indurite e fissate attraverso il processo di Electron Beam Curing. Grazie a queste caratteristiche FENIX NTM® si rigenera da eventuali micrograffi superficiali grazie alla termoriparabilità.

RECYCLED FIBERGLASS

Made of recycled material, obtained from the recovery of fiberglass and other post-consumption fibre-reinforced composites. They are re-aggregated at high pressure ensuring the product robustness and stability in all environmental conditions. Eco-sustainable and recyclable material at the end of life.

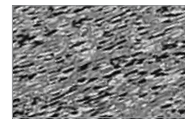

RFS01
Recycled fiberglass

MARBLE

Carnic grey marble, polyester varnished, matt finish, stain resistant.



MRM01
White Carrara

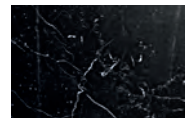

MRM02
Black Marquina

LEATHER

Top quality European full-grain leather is used for the infinity upholstery. Several are the possibilities to chose among leather of different shades.



PN
Nero
Black



PTM
Testa di Moro
Dark brown



PC
Cuio
Cuio

Fibra di vetro riciclata

Realizzato con materiale riciclato, ricavato dal recupero della vetroresina e di altri compositi fibrorinforzati postconsumo. Sono riaggregati a pressione elevata garantendo al prodotto robustezza e stabilità in ogni condizione ambientale. Materiale ecosostenibile e nuovamente riciclabile a fine vita.

Marmo

Marmo grigio carnico, verniciato poliestere, finitura opaca, antimacchia.

Pelle

Le pelli che caratterizzano i rivestimenti delle creazioni infinity sono di assoluta qualità, come le pelli fiore provenienti da bovini europei.

B-CHEW TRIO ABITEX

The first bi-elastic fire retardant fabric made in Italy is indoor and outdoor. B-chew originate with this premise: eco-sustainable, recycled and recyclable made out of recycled PET. Ethical, multifaceted, b-chew can adapt to any shape, emphasizing the infinite design possibilities it allows.



BC103

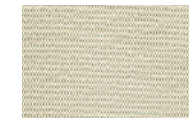

BC104

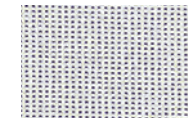

BC106

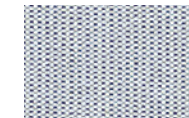

BC107



BC305

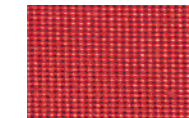

BC307



BC605



BC703



BC705



BC803



BC807

MIAMI PINTAIL

100% waterproof and water repellent outdoor fabric with high light fastness suitable for example for outdoor cushions.



PM1102

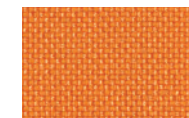

PM2009

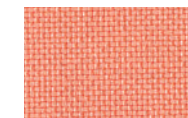

PM3560



PM1986



PM3001

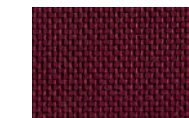

PM11-3006

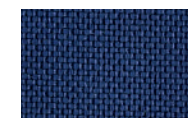

PM11-5010

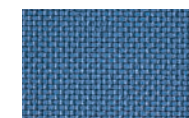

PM5011

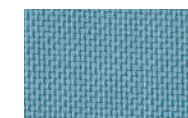

PM10-5018



PM11-5004



PM5001



PM7746

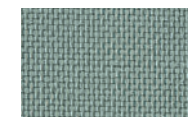

PM10-6025



PM11-6007

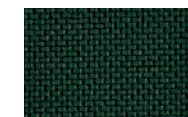

PM13-6003

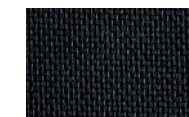

PM1000

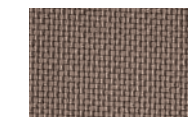

PM11-8008



PM7744

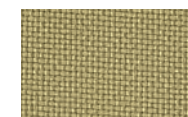

PM6003



PM0000

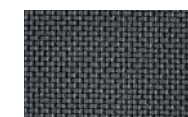

PM11-7004



PM0978

Miami Pintail

Tessuto per esterni 100% impermeabile e idrorepellente con alta resistenza alla luce, adatto ad esempio per cuscini per esterni.

NAUTICAL ROPE

Nautical rope UV Stabilized is based on a PET polymer able to reduce the polymer chain deterioration caused by UV rays. UV radiations damage the bonds of standard PET weakening its filaments. This yarn absorbs and dissipates UV rays thus limiting polymer deterioration. Nautical rope is a high-performance flame retardant (FR) polyester whose FR properties are incorporated into the polymer; no post-treatment is needed, and no deterioration occurs during maintenance treatments.



Corda Marina

La corda nautica stabilizzata UV è basata su un polimero PET in grado di ridurre il deterioramento della catena polimerica causato dai raggi UV. Le radiazioni UV danneggiano i legami del PET standard indebolendone i filamenti. Questo filato assorbe i raggi UV limitandone così il deterioramento. La corda nautica è di poliestere ignifugo (FR) ad alte prestazioni, le cui proprietà sono incorporate nel polimero; non è necessario quindi alcun post-trattamento e non si verifica alcun deterioramento durante i trattamenti di mantenimento.

Symbols



SUN AND UV RESISTANT

Material suitable for outdoor use, resistant to fading and color degradation effects.

RESISTENTE AL SOLE E AI RAGGI UV

Materiale adatto all'utilizzo esterno resistente agli effetti di sbiadimento e degradazione del colore.



WATER AND STAIN RESISTANT

Material suitable for outdoor use with a treatment that delays the absorption of water-based stains.

RESISTENTE ALL'ACQUA E ALLE MACCHIE

Materiale adatto all'utilizzo esterno con trattamento che ritarda l'assorbimento delle macchie a base acquosa.



WATER AND STAIN REPELLENT

Material suitable for outdoor use with treatment that prevents the penetration of water-based stains.

IDROREPELENTE E ANTI MACCHIA

Materiale adatto all'utilizzo esterno con trattamento che impedisce la penetrazione delle macchie a base acquosa.



EASY CARE

Material suitable for outdoor use and easily washable with water only and common household non aggressive detergents.

FACILE MANUTENZIONE E PULIZIA

Materiale adatto all'utilizzo esterno e facilmente lavabile con sola acqua e comuni detergenti domestici non aggressivi.

infiniti

Via Ca' Leoncino, 2 - 31030
Castello di Godego (TV) - Italy

T +39 0423 7616
infinitidesign.it

infiniti reserves the right to introduce any changes to its own models, without prior notice.

The printing ink cannot exactly reproduce the colours. For higher accuracy with suggest inspecting the colour samples.

Styling
Cristina Romanello

3D Images
bruger studio
brugerstudio.com

Colour separation
and Print
kappadue Arti
Grafiche
kappadue.net



Concept and Design
THE TAILORS
thetailors.it

You know, I take advice:
every time I pass an
almond tree in bloom,
I take my hat off to it.

*Lo sai, seguo il consiglio:
ogni volta che passo
davanti ad un mandorlo
in fiore mi tolgo il
cappello.*

ERMANNOLMI

infiniti