

OFFIC'E'

GO

9 Cambiano i volumi

New volumes  
Cambian los volúmenes  
Les volumes changent

47 Riflettere eleganza

Reflect elegance  
Reflejar elegancia  
Refléter l'élégance

83 Incontrare il Team

Meet the team  
Encontrar el equipo  
Rencontrer l'équipe

97 Informazioni tecniche

Technical information  
Informaciones técnicas  
Informations techniques

# Respect

for the

environment

## Green technologies

 We choose 100% natural materials with an excellent performance from innovative processes such as sintering technology which allows ceramic stone to be created without using adhesives or polluting substances. We have adopted the use of Greenguard-certified organic paint that ensures low emissions and better air quality in home environments.

## Innovation

 We are always on the lookout for unique material and raw materials allowing us to offer the market high-quality products with a signature design. We have introduced an artificial intelligence system that plans production, maximizes productivity and facilitates logistics and sorting operations by reducing waste significantly.

## Product durability

 We design products that last longer to reduce waste and offer high quality standards.

## Eco-friendly materials

 We use glass and aluminium, infinitely recyclable materials to develop hard-wearing products with a strong visual impact, and PET for safe surfaces without toxic emissions either during production or use.

## Internal logistics

 We have optimised all internal company logistics to reduce energy wastage and CO<sub>2</sub> production to a minimum.

## Transport

 We organise shipments by optimising space and delivery routes to reduce CO<sub>2</sub> emissions on the planet.

## Green-living attitude

 We have eliminated the use of plastic in our offices and production department by installing water dispensers, and recover all the waste we produce through our industrial activities.

## Special projects

 We are joining the Furniture Pact, an industry-led, collaborative initiative that promotes and upholds common sustainability goals for the furniture sector in Italy, including the social and environmental impact of its value chain.

## Space optimisation

 We reduce building material waste by optimising spaces with our own furniture solutions, perfectly adaptable to different architectures thanks to their extensive modularity and customisation.

## Energy diagnosis

 We constantly monitor our total consumption and define systemic improvement actions to optimise our energy impact.

## UNI EN ISO 14001

 We have certified our environmental management system in compliance with standard UNI EN ISO 14001.

## Packaging

 We use only boxes made of recycled paper, gradually reducing the use of plastic, to be completely replaced with eco-friendly materials.

## Circular economy

 We produce melamine-faced structures and doors consisting of ecological panels produced by FSC® certified suppliers who use pre- and post-consumer wood, which is given a second life thanks to a self-perpetuating circular economy, without impacting our existing forests.

# Rispetto dell'ambiente

## Tecnologie green

Scegliamo materiali naturali al 100% resi straordinari da processi innovativi come la tecnologia di sinterizzazione che permette di creare pietre ceramiche senza l'utilizzo di colle e sostanze inquinanti. Abbiamo adottato l'utilizzo di vernici bio certificate Greenguard che garantiscono basse emissioni e una migliore qualità dell'aria negli ambienti domestici.

## Innovazione

Siamo sempre alla ricerca di materiali e materie prime uniche che ci permettono di proporre sul mercato prodotti di alta qualità dal design distintivo. Abbiamo introdotto un sistema di intelligenza artificiale che pianifica la produzione, massimizza la produttività e facilita le operazioni di logistica e smistamento riducendo, in maniera significativa, gli sprechi.

## Durabilità dei prodotti

Progettiamo prodotti con una maggiore vita utile per ridurre i rifiuti e offrire alti standard qualitativi.

## Materiali eco-friendly

Utilizziamo vetro e alluminio, riciclabili all'infinito per realizzare prodotti resistenti e di grande impatto estetico, e PET per superfici sicure che non rilasciano alcuna emissione tossica durante il ciclo di produzione e utilizzo.

## Logistica interna

Abbiamo ottimizzato tutte le movimentazioni all'interno dell'azienda per ridurre al minimo lo spreco di risorse energetiche e la produzione di CO<sub>2</sub>.

## Trasporto

Organizziamo le spedizioni ottimizzando gli spazi e i percorsi delle consegne per ridurre le emissioni di CO<sub>2</sub> sul pianeta.

## Attitudine green-living

Abbiamo azzerato l'utilizzo della plastica negli uffici e nella produzione installando distributori d'acqua e recuperiamo tutti i rifiuti che produciamo con la nostra attività industriale.

## Progetti speciali

Aderiamo al Furniture Pact, un'iniziativa collettiva della filiera italiana dell'arredo. I membri promuovono obiettivi comuni di sostenibilità, coinvolgendo l'intera catena del valore, e hanno sottoscritto impegni ambiziosi ma concreti per ridurre il proprio impatto sull'ambiente e sulle persone.

## Ottimizzazione degli spazi

Riduciamo lo spreco dei materiali da costruzione ottimizzando gli spazi con le nostre soluzioni di arredo che si adattano alle diverse architetture grazie alla loro ampia modularità e personalizzazione.

## Diagnosi energetica

Monitoriamo costantemente i consumi totali e definiamo azioni di miglioramento sistemico per ottimizzare il nostro impatto energetico.

## UNI EN ISO 14001

Abbiamo certificato il nostro sistema di gestione ambientale in conformità agli standard alla norma UNI EN ISO 14001.

## Imballaggi

Impieghiamo solo cartoni realizzati con carta riciclata, riducendo progressivamente l'uso della plastica per sostituirla completamente con materiali green.

## Economia circolare

Produciamo strutture e ante in nobilitato costituite da pannelli ecologici provenienti da fornitori certificati FSC® che utilizzano legno pre e post-consumo a cui viene data una seconda vita in virtù di un'economia circolare che si autoalimenta, senza andare a intaccare il nostro patrimonio forestale.

# Go, il colore si struttura

**Il colore si struttura e cambia il nostro modo di guardare lo spazio; sottolinea i volumi, si compiace di essere notato.**

Colour structures itself and alters how we see the space; it highlights volumes and delights in being noticed.

El color se estructura y cambia nuestra forma de ver el espacio; acentúa los volúmenes, se deleita haciéndose notar.

La couleur se structure et change notre façon de regarder l'espace; elle souligne les volumes, elle se complait à être remarquée.

Go, colour structures itself  
Go, el color se estructura  
Go, la couleur se structure



# Nuove alleanze luminose

New bright alliances  
Nuevas alianzas luminosas  
De nouvelles alliances brillantes

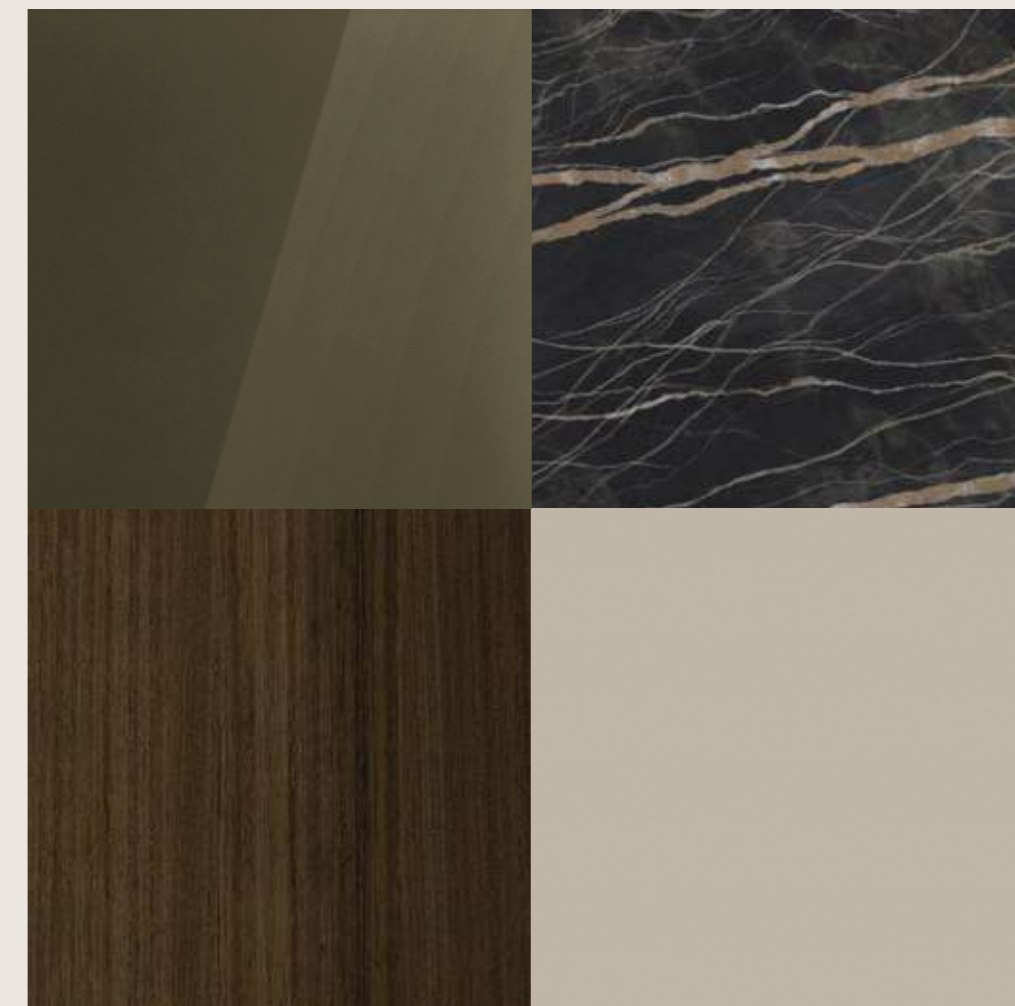

**Cambia il nostro modo di percepire e leggere le forme. Nuovi accostamenti di tinta e di materiale, reinterpretano l'arredo ufficio con nuove, interessanti sfumature...**

It changes how we perceive and view forms. New colour and material combinations reinterpret the office furniture with new and exciting nuances...

Cambia nuestro modo de percibir y leer las formas. Nuevas combinaciones de tinta y materiales reinterpretan el mobiliario de oficina con nuevos e interesantes matices...

Elle change notre façon de percevoir et de lire les formes. De nouvelles associations de teinte et de matériau, réinterprètent le mobilier de bureau avec des nuances nouvelles et intéressantes...



## Il colore interpreta la forma e la funzione

Colour interprets form and function  
El color interpreta la forma y la función  
La couleur interprète la forme et la fonction



## I volumi sono giochi di sporgenze

Volumes are a play on projections  
Los volúmenes son juegos de salientes  
Les volumes sont des jeux de saillies

**Il mobile di servizio accoglie un nuovo volume che può essere collocato a maggiore o minore sporgenza.**

The service unit welcomes a new volume that can be more or less projected.

El mueble de servicio aloja un nuevo volumen que puede colocarse con mayor o menor saliente.

Le meuble de service accueille un nouveau volume pouvant être placé avec une saillie plus ou moins importante.



# CAMBIANO I VOLUMI

New volumes  
Cambian los volúmenes  
Les volumes changent













































# RIFLETTERE ELEGANZA

Reflect elegance  
Reflejar elegancia  
Réfléter l'élégance







































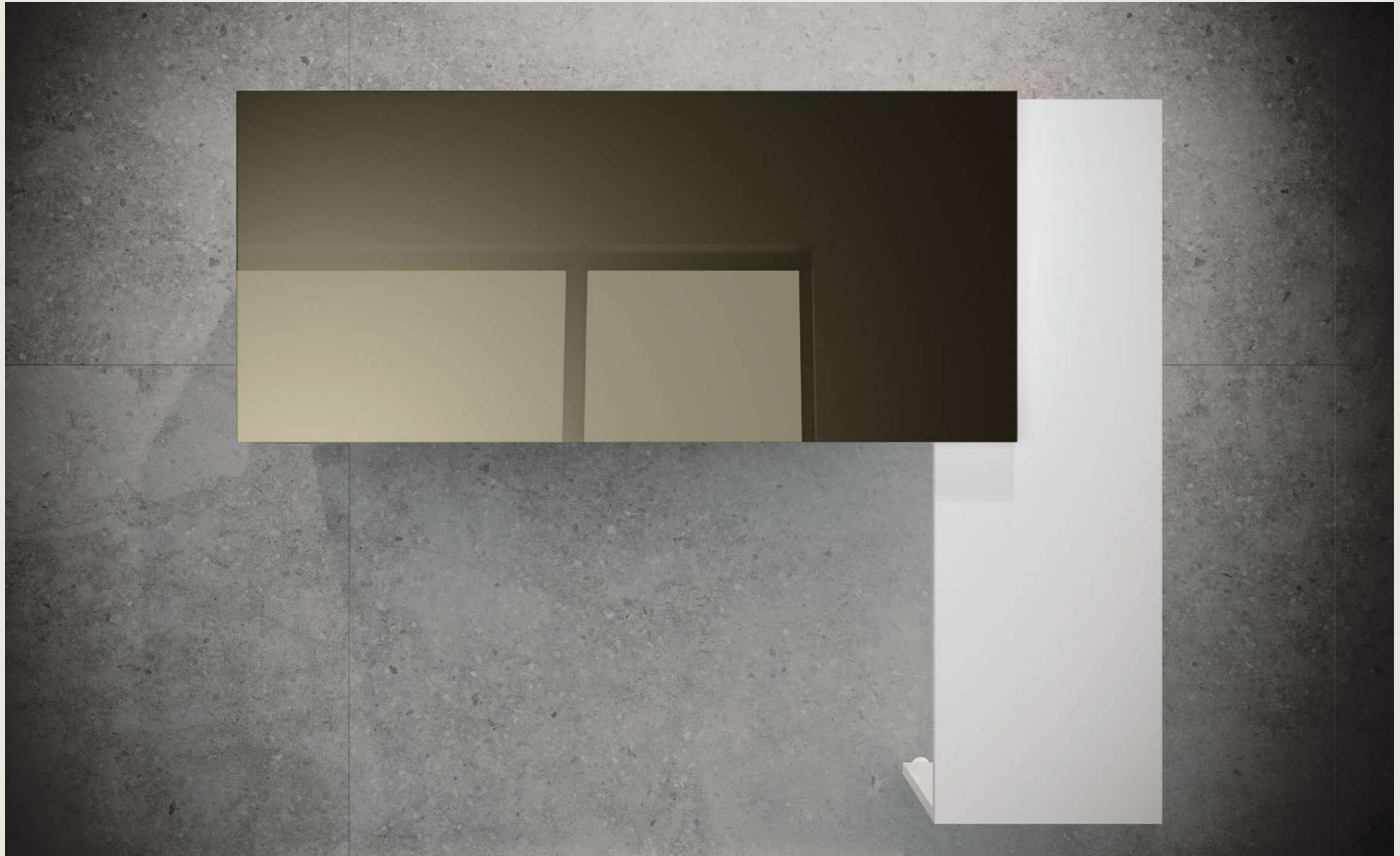

# INCONTRARE IL TEAM

Meet the team  
Encontrar el equipo  
Rencontrer l'équipe















# Informazioni tecniche

Technical information  
Informaciones técnicas  
Informations techniques

## Scrivanie

Desks / Escritorios / Bureaux



### Scrivanie lineari

Linear desks / Escritorios lineales / Bureaux linéaires

L	P	H
100		
120	60	
140		75
160	60-90	
180		
200	90	

### Scrivanie con sostegno a L

Desks with "L" shaped support / Escritorios con soporte en "L" / Bureaux avec soutien en "L"

L	P	H
200		
220	90-190	75
240		

### Scrivanie con mobile di sostegno

Desks with support units / Escritorios con muebles de sustentación / Bureaux avec meubles de soutènement

L	P	H
200	178	
220		75
240	90-178	
260		

### Scrivanie ad angolo

Corner desks / Escritorios rinconero / Bureaux d'angle

L	P	H
160		
180	190	75
200		

### Piano in melaminico

Melamine top / Tablero de melamina / Plan en mélamine

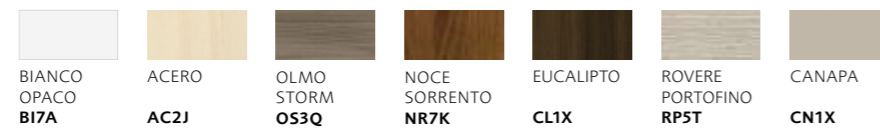
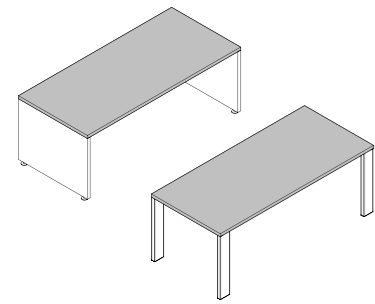

### GO EASY - Sostegni in melaminico

Melamine supports / Soportes de melamina / Soutiens en mélamine

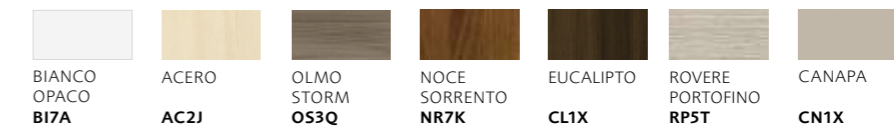
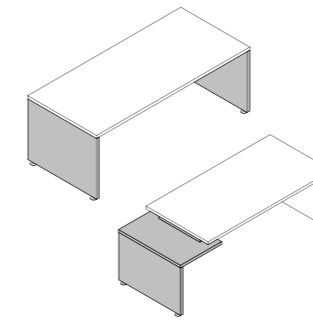

### Piano in vetro

Glass top / Tablero de vidrio / Plan en verre

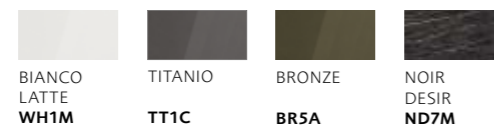
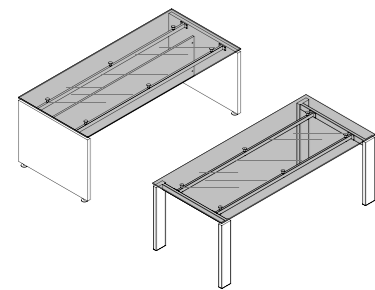

### Modesty panel e pannello retro in melaminico

Melamine modesty panel and back panel / Panel modesty y panel posterior de melamina / Panneau modesty et panneau arrièrre en mélamine

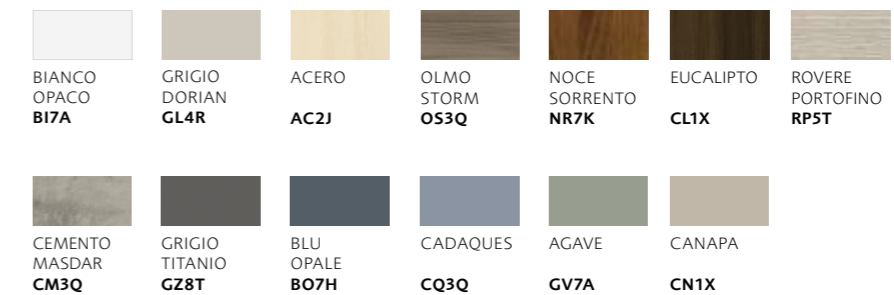
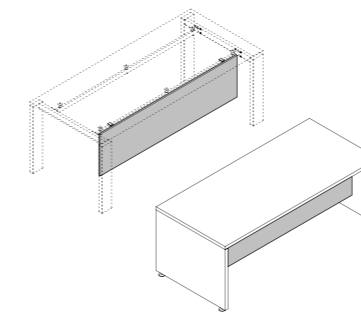

### Travi in metallo

Metal beams / Viguetas de metal / Poutres en métal

#### GO EASY

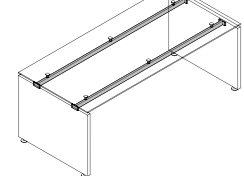

#### GO STEEL



### GO STEEL - Sostegno in metallo

Metal support / Soporte de metal / Soutien en métal

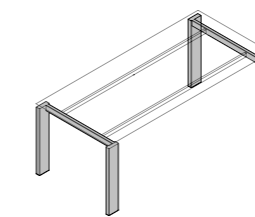

## Mobili di sostegno

Support units / Muebles de sustentación / Meubles de soutènement



L	P	H
80	90	60,5
60-80	178	

### Struttura

Structure / Estructura / Structure

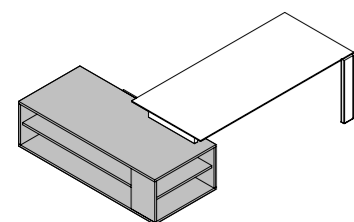

BIANCO OPACO <b>B17A</b>	ACERO <b>AC2J</b>	OLMO STORM <b>OS3Q</b>	NOCE SORRENTO <b>NR7K</b>	EUCALIPTO <b>CL1X</b>	ROVERE PORTOFINO <b>RP5T</b>	CANAPA <b>CN1X</b>

### Facciate

Fronts / Frentes / Façades

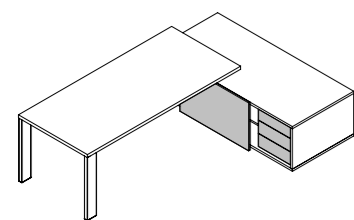

BIANCO OPACO <b>B17A</b>	GRIGIO DORIAN <b>GL4R</b>	ACERO <b>AC2J</b>	OLMO STORM <b>OS3Q</b>	NOCE SORRENTO <b>NR7K</b>	EUCALIPTO <b>CL1X</b>	ROVERE PORTOFINO <b>RP5T</b>
CEMENTO MASDAR <b>CM3Q</b>	GRIGIO TITANIO <b>GZ8T</b>	BLU OPALE <b>B07H</b>	CADAQUES <b>CQ3Q</b>	AGAVE <b>GV7A</b>	CANAPA <b>CN1X</b>	

### Inserto

Insert / Inserto / Insert

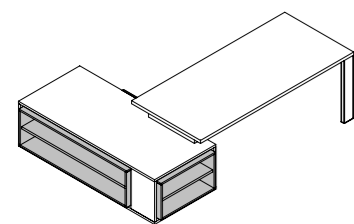

BIANCO OPACO <b>B17A</b>	GRIGIO DORIAN <b>GL4R</b>	ACERO <b>AC2J</b>	OLMO STORM <b>OS3Q</b>	NOCE SORRENTO <b>NR7K</b>	EUCALIPTO <b>CL1X</b>	ROVERE PORTOFINO <b>RP5T</b>
CEMENTO MASDAR <b>CM3Q</b>	GRIGIO TITANIO <b>GZ8T</b>	BLU OPALE <b>B07H</b>	CADAQUES <b>CQ3Q</b>	AGAVE <b>GV7A</b>	CANAPA <b>CN1X</b>	

## Mobili di servizio

Service units / Muebles de servicio / Meubles de service



L	P	H
93,8		
136,9		
138,8	59,7	60,5
181,8		
183,8		
226,7		

### Struttura

Structure / Estructura / Structure

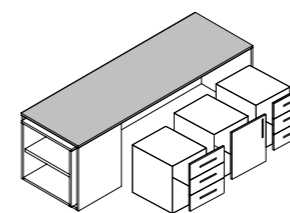

BIANCO OPACO <b>B17A</b>	ACERO <b>AC2J</b>	OLMO STORM <b>OS3Q</b>	NOCE SORRENTO <b>NR7K</b>	EUCALIPTO <b>CL1X</b>	ROVERE PORTOFINO <b>RP5T</b>	CANAPA <b>CN1X</b>

### Fianchi e schiena

Sides and back  
Lados y trasera  
Côtés et arrière

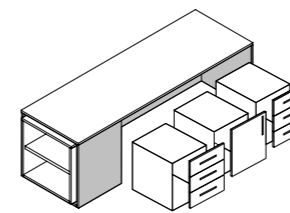

BIANCO OPACO <b>B17A</b>	ACERO <b>AC2J</b>	OLMO STORM <b>OS3Q</b>	NOCE SORRENTO <b>NR7K</b>	EUCALIPTO <b>CL1X</b>	ROVERE PORTOFINO <b>RP5T</b>	CANAPA <b>CN1X</b>

### Inserto

Insert  
Inserto  
Insert

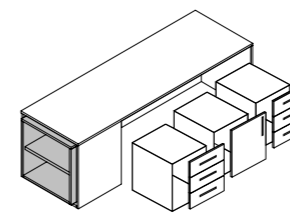

BIANCO OPACO <b>B17A</b>	GRIGIO DORIAN <b>GL4R</b>	ACERO <b>AC2J</b>	OLMO STORM <b>OS3Q</b>	NOCE SORRENTO <b>NR7K</b>	EUCALIPTO <b>CL1X</b>	ROVERE PORTOFINO <b>RP5T</b>
CEMENTO MASDAR <b>CM3Q</b>	GRIGIO TITANIO <b>GZ8T</b>	BLU OPALE <b>B07H</b>	CADAQUES <b>CQ3Q</b>	AGAVE <b>GV7A</b>	CANAPA <b>CN1X</b>	

### Elementi mobili di servizio

Elements for service units / Elementos para muebles de servicio / Éléments pour meubles de service

### Cassa

Carcase  
Estructura  
Structure

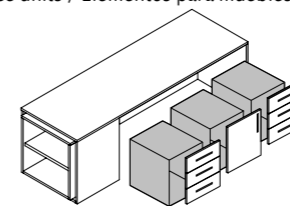

BIANCO OPACO <b>B17A</b>	GRIGIO DORIAN <b>GL4R</b>

### Facciate

Fronts  
Frentes  
Façades

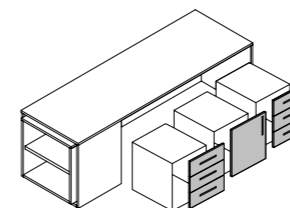

BIANCO OPACO <b>B17A</b>	GRIGIO DORIAN <b>GL4R</b>	ACERO <b>AC2J</b>	OLMO STORM <b>OS3Q</b>	NOCE SORRENTO <b>NR7K</b>	EUCALIPTO <b>CL1X</b>	ROVERE PORTOFINO <b>RP5T</b>	CANAPA <b>CN1X</b>

## Tavoli riunione

Meeting tables / Mesas de reunión / Tables de réunion



L	P	H
120	120	75
150	150	
240	120-150	
260	150	
280		
300		
320		
340		
360		
380		
400		

### Piano in melaminico

Melamine tops / Tablero de melamina / Plan en mélamine

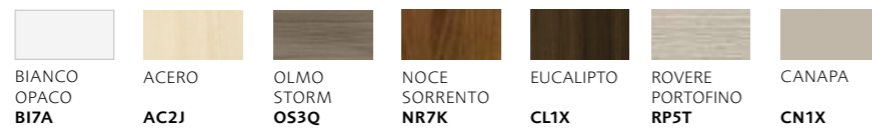
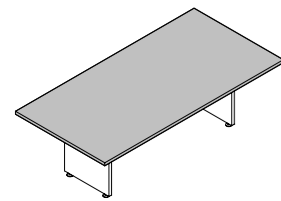

### GO EASY - Traversa in melaminico

Melamine crossbeam / Traversaño de melamina / Traversé en mélamine

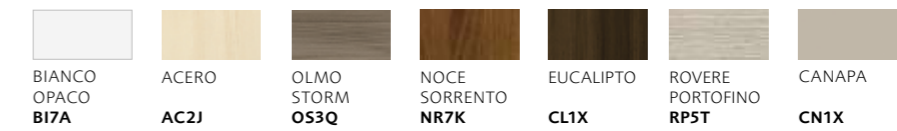
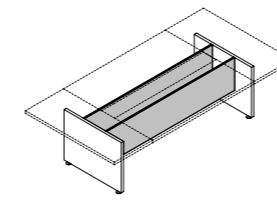

### Copertura in melaminico

Melamine overlay / Cubierta de melamina / Couverture en mélamine

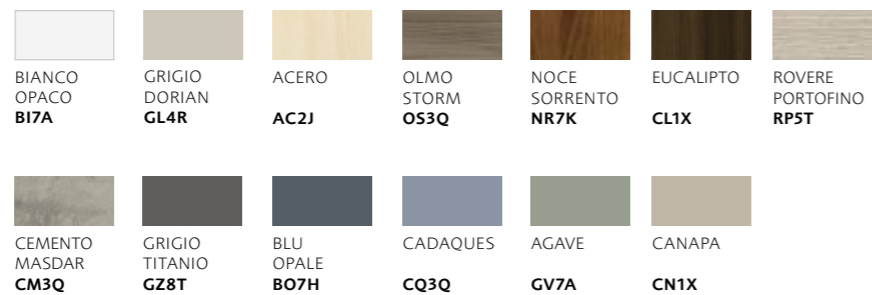
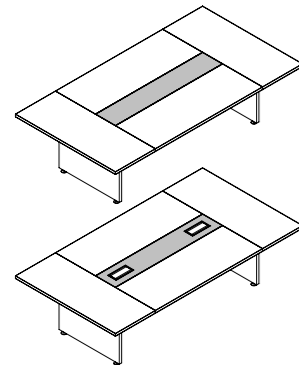

### GO STEEL - Sostegno in metallo

Metal support / Soporte de metal / Soutien en métal

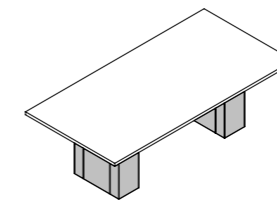

### GO EASY - Sostegno in melaminico

Melamine support / Soporte de melamina / Soutien en mélamine

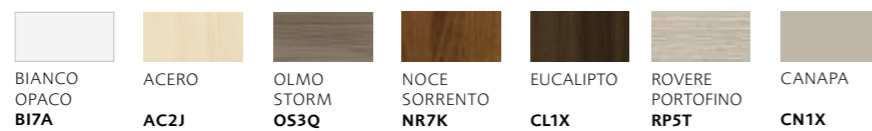
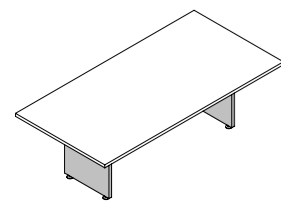

## Maniglie

Handles / Tiradores / Poignées

**U13G**  
P11  
\*

**Legno**  
Wood  
Madera  
Bois



**U16S**  
PIN  
\*

**Alluminio**  
Aluminium  
Aluminio  
Aluminium



**U00V**  
LIG

**ABS**



**U15A**  
BIS

**Alluminio**  
Aluminium  
Aluminio  
Aluminium



**U11E**  
PUL

**Legno**  
Wood  
Madera  
Bois

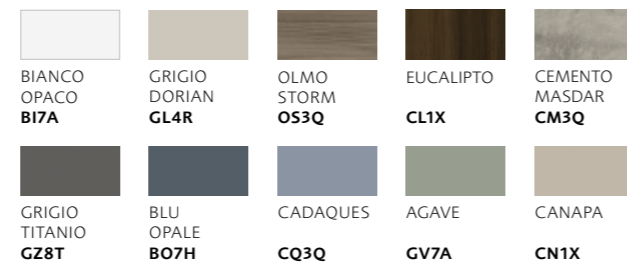

\* Non disponibile per cassetti  
Not available for drawers  
No disponible para cajones  
Non disponible pour tiroirs

## Maniglie

Handles / Tiradores / Poignées

**U02B**  
SNIP

**Alluminio**  
Aluminium  
Aluminio  
Aluminium

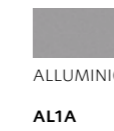

**U09Z**  
RAN

**ABS**

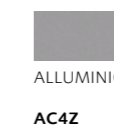

**U12F**  
VIM

**Legno**  
Wood  
Madera  
Bois

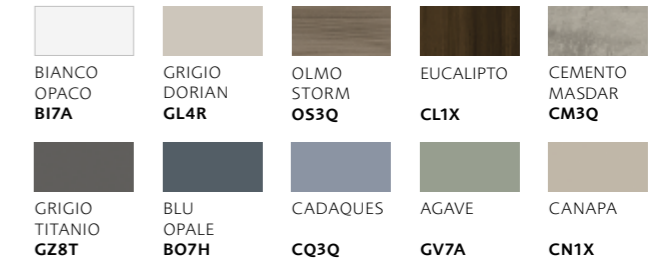

**U17V**  
BUL

**Alluminio**  
Aluminium  
Aluminio  
Aluminium



**V20A**  
PUSH-PULL  
\*\*

**Alluminio**  
Aluminium  
Aluminio  
Aluminium

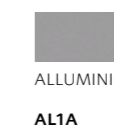

\*\* Solo per anta battente senza serratura  
Only for panel door without lock  
Sólo para puerta de madera sin cerradura  
Seulement pour porte en bois sans serrure

## Accessori

Accessories / Accesorios / Accessoires

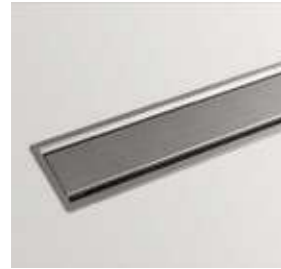

Top access  
Access top  
Top access  
Top access



Passacavo elettrificato con  
ricarica wireless  
Electrified cable grommet  
with wireless charging



Pasacable electrificado con  
recarga inalámbrica  
Passe-câble électrifié avec  
recharge sans fil



Torretta elettrificata  
Wired tower  
Torreta electrificada  
Bloc prises



Ricarica wireless  
Wireless charge  
Recarga wireless  
Chargeur sans fil



Accessorio multipresa  
Multi-socket accessory  
Accesorio multi-enchufe  
Accessoire multiprise



A blank sheet of lined paper with 20 horizontal lines.



A blank sheet of graph paper with a grid of 14 columns and 20 rows.





---

---

---

---

---

---

---

---

---

---

---

---

---

---

---

---

---

---

---

---

---

---

---

---



Ricerca e coordinamento  
**Colombini S.p.A.**

Impaginazione  
**Biefferender Verona**  
Fotografia  
**Biefferender Verona**  
Fotolito  
**Biefferender Verona**

La Colombini S.p.A. si riserva  
di apportare, senza alcun preavviso,  
le modifiche che riterrà più opportune  
al fine di migliorare il prodotto.

OFFIC'E'  
COLOMBINI S.p.A.

Azienda certificata UNI EN ISO 9001  
Azienda certificata UNI EN ISO 14001  
Strada Ca' Valentino, 124  
47891 - Falciano - Repubblica di San Marino

Telefono da Italia 0549 943 573  
International calls +378 0549 975 948

[www.officecolombinigroup.com](http://www.officecolombinigroup.com)